

# Assembly Instruction

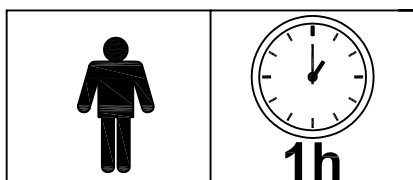

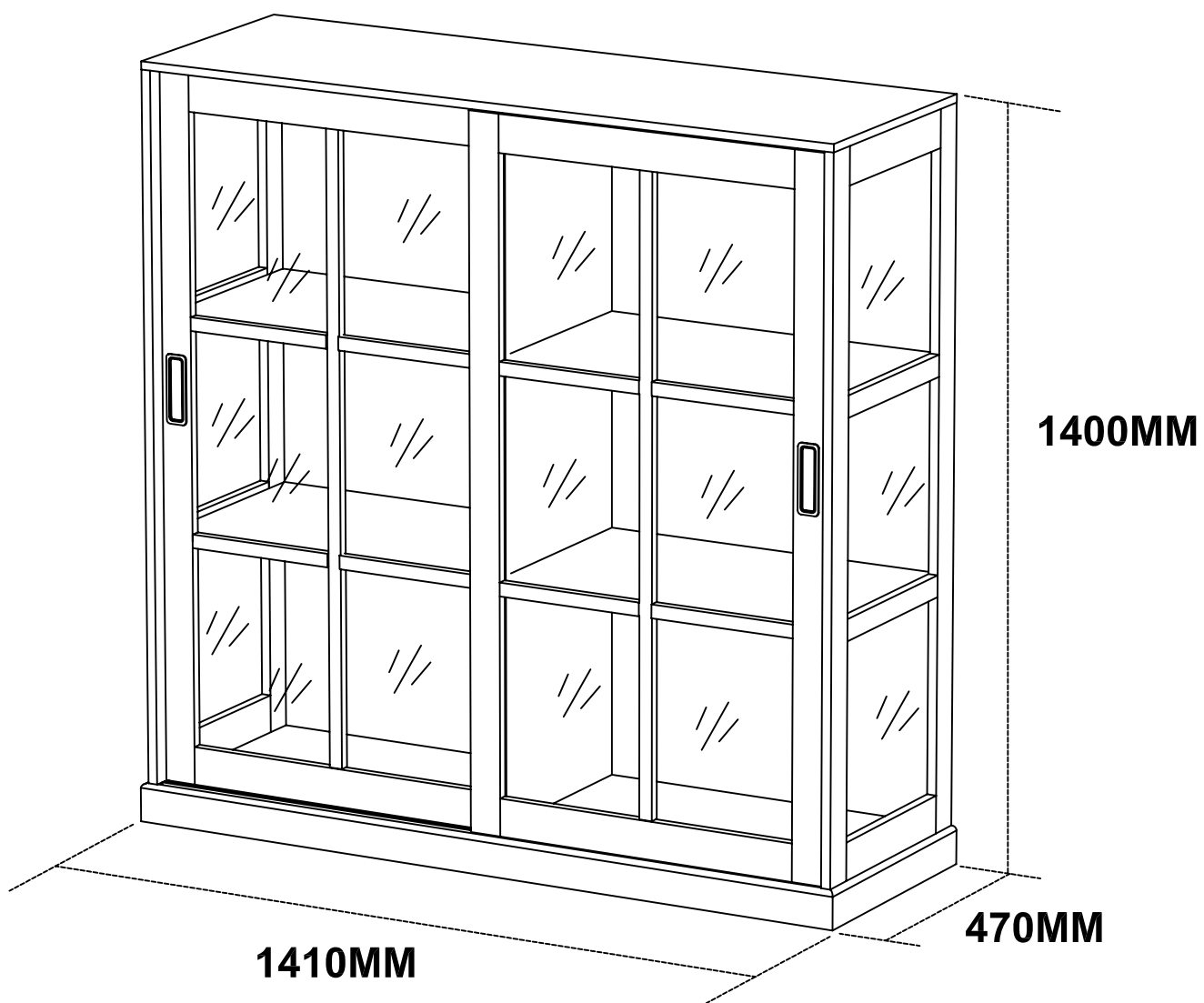
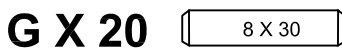
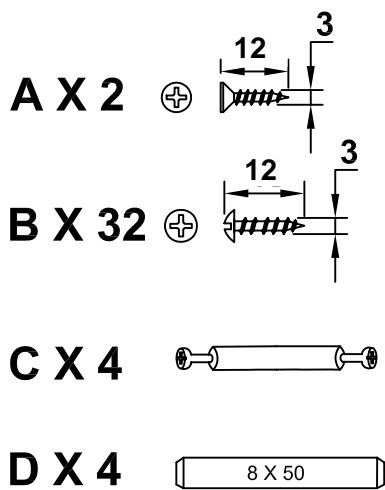
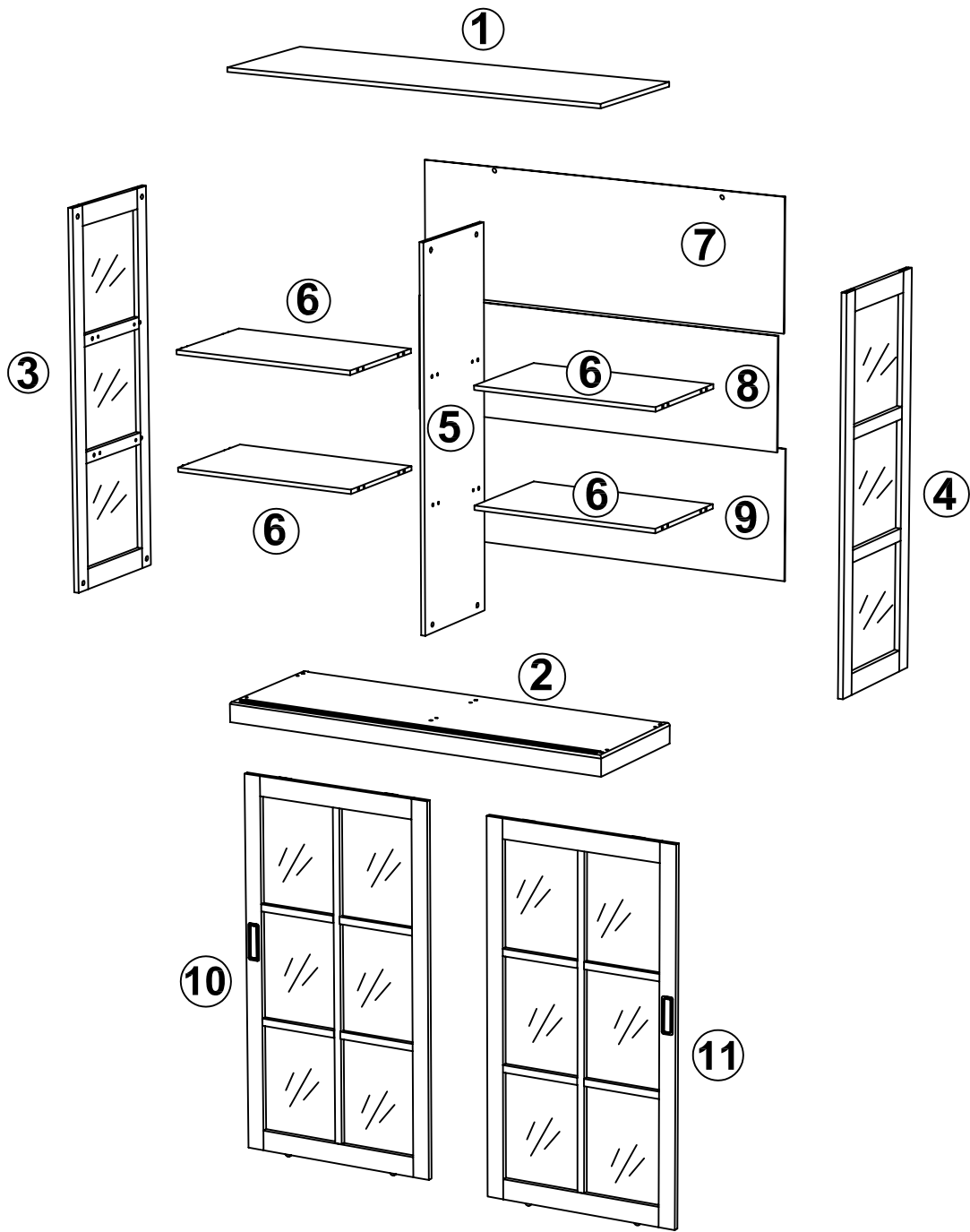

unit:mm

1

A X 2  

H X 2 

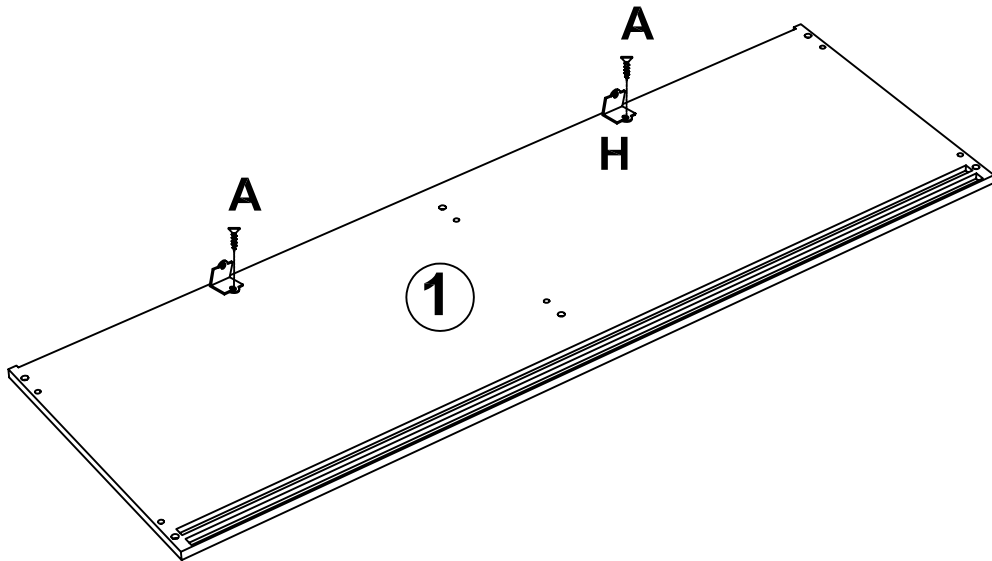

2

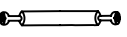
C X 4 

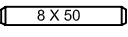
D X 4  8 X 50

F X 8 

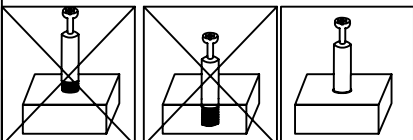
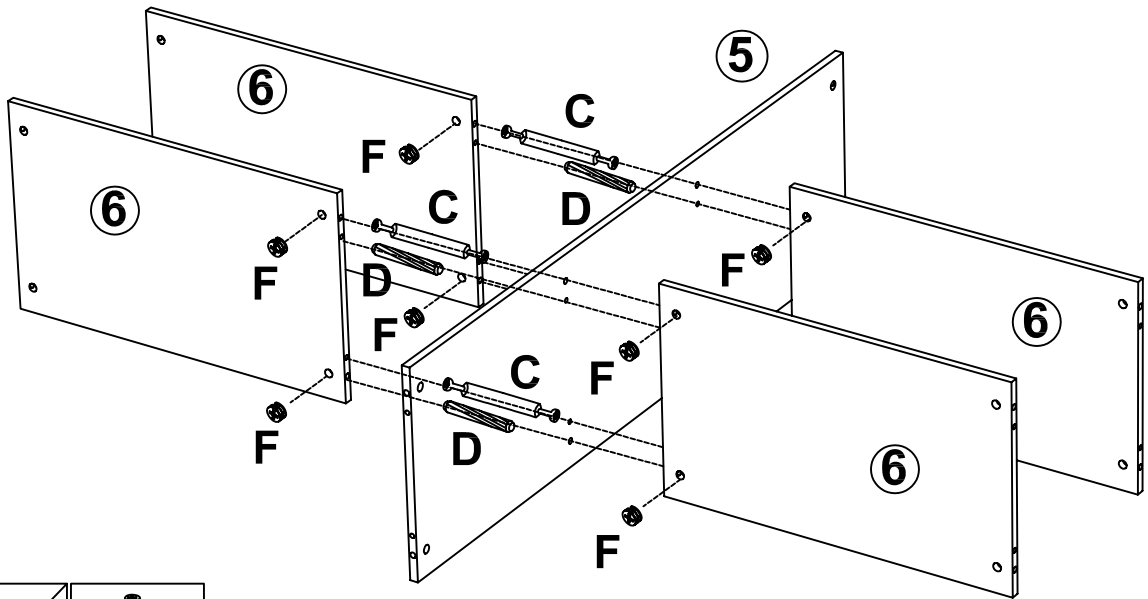

3

EX 4 

FX 4 

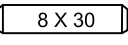
GX 4  8 X 30

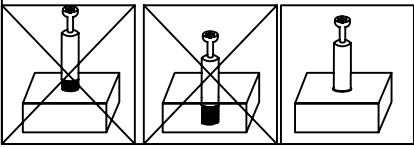
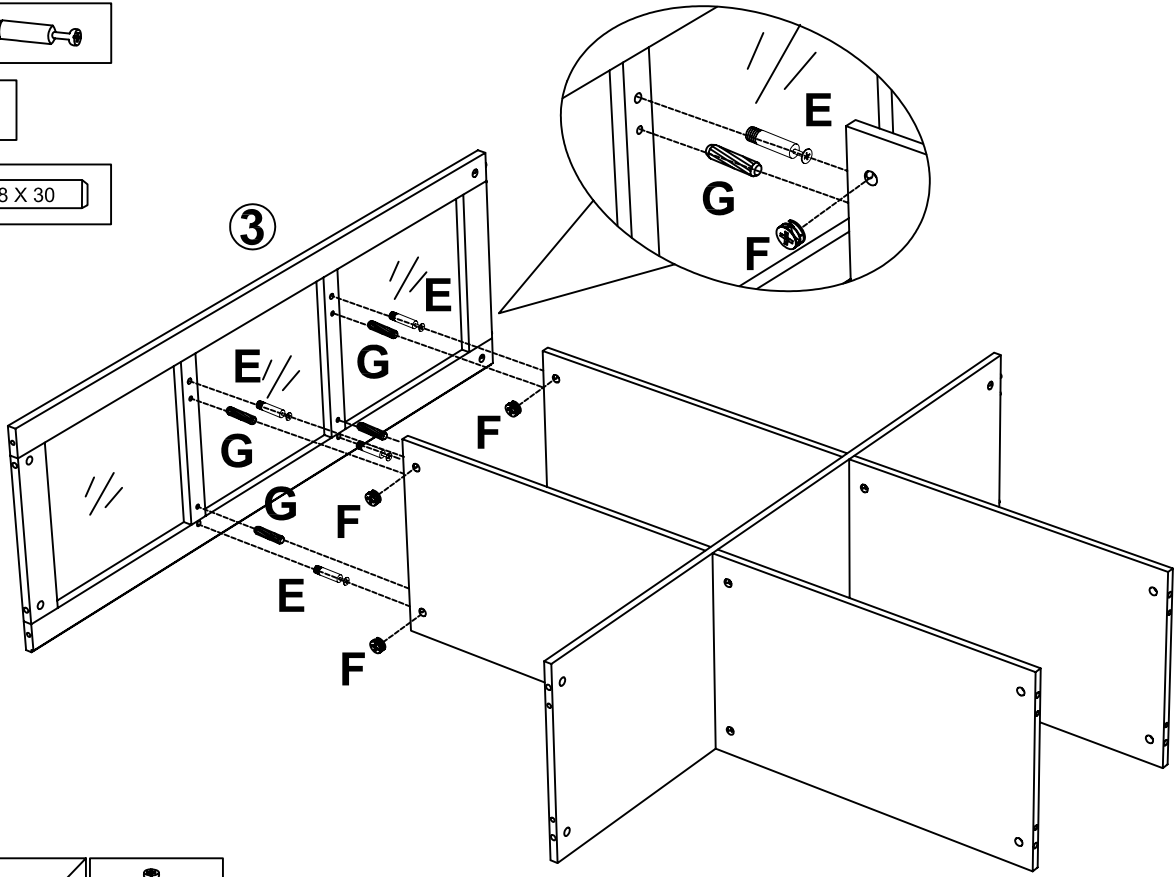

4

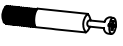
EX 4 

FX 4 

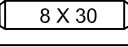
GX 4  8 X 30

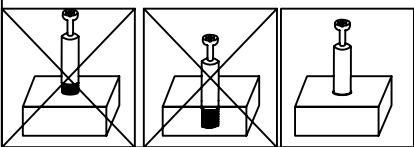
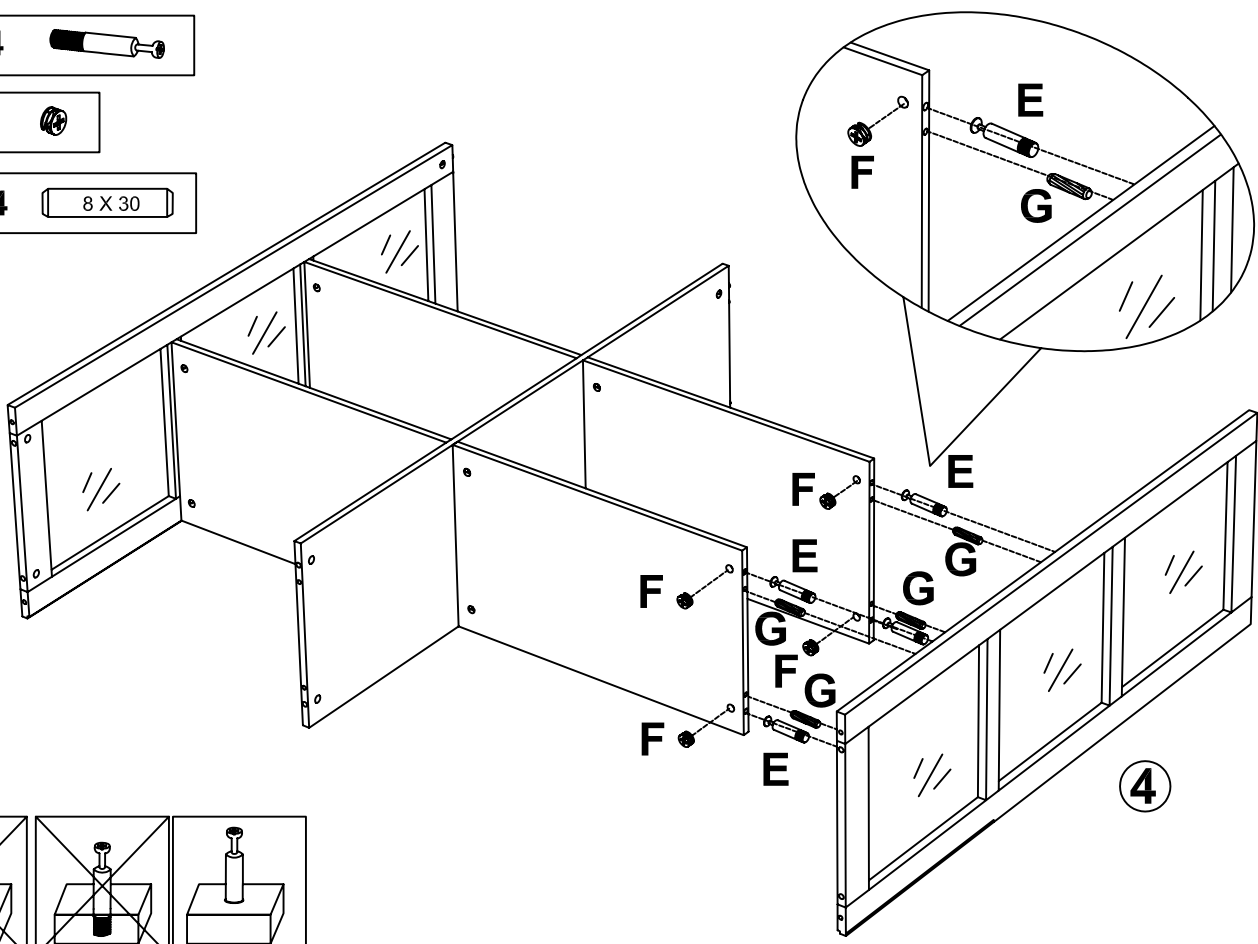

5

EX 6



FX 6



G X 6

8 X 30

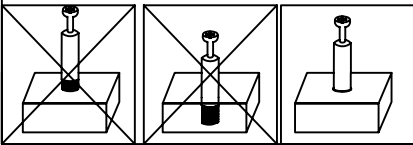
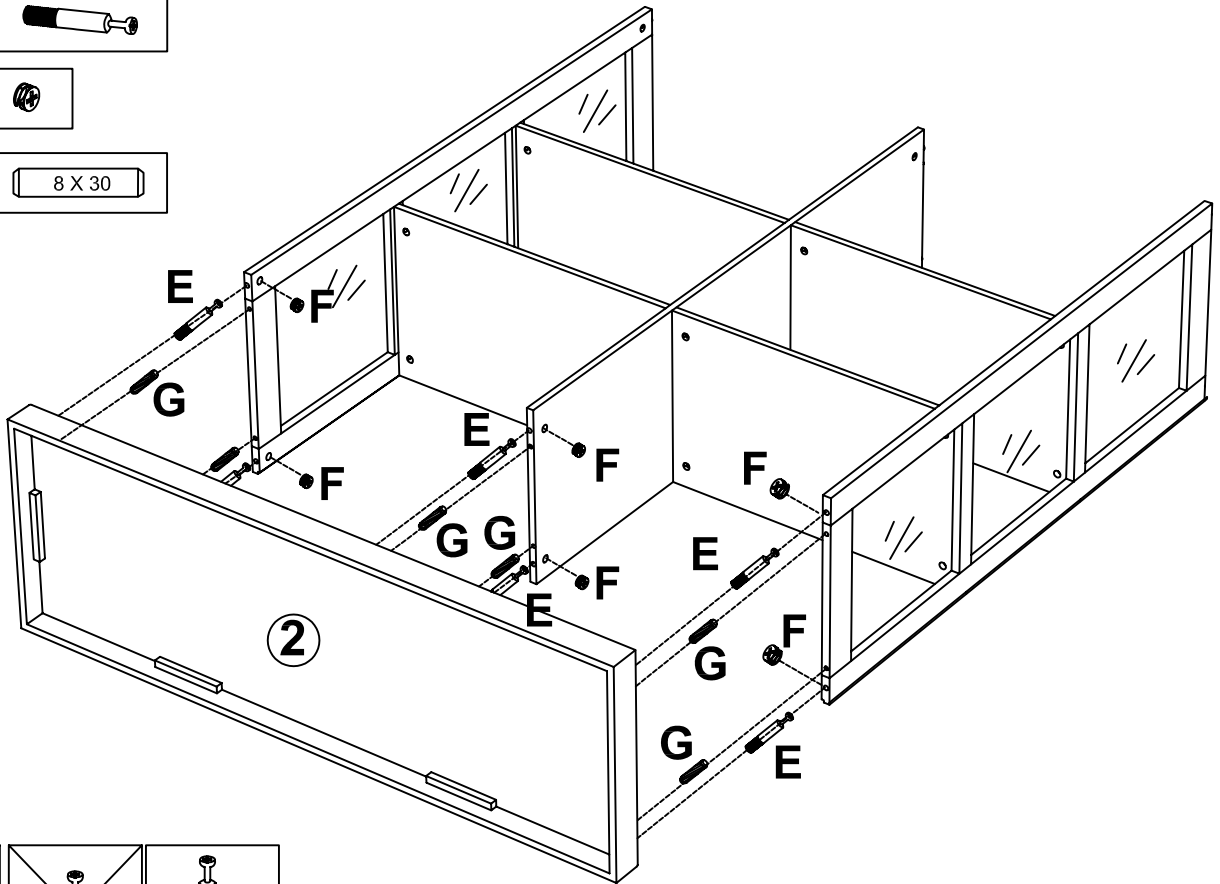

6

EX 6



FX 6



G X 6

8 X 30

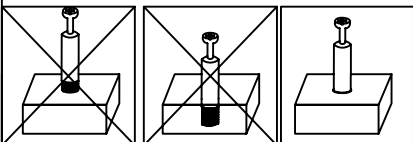
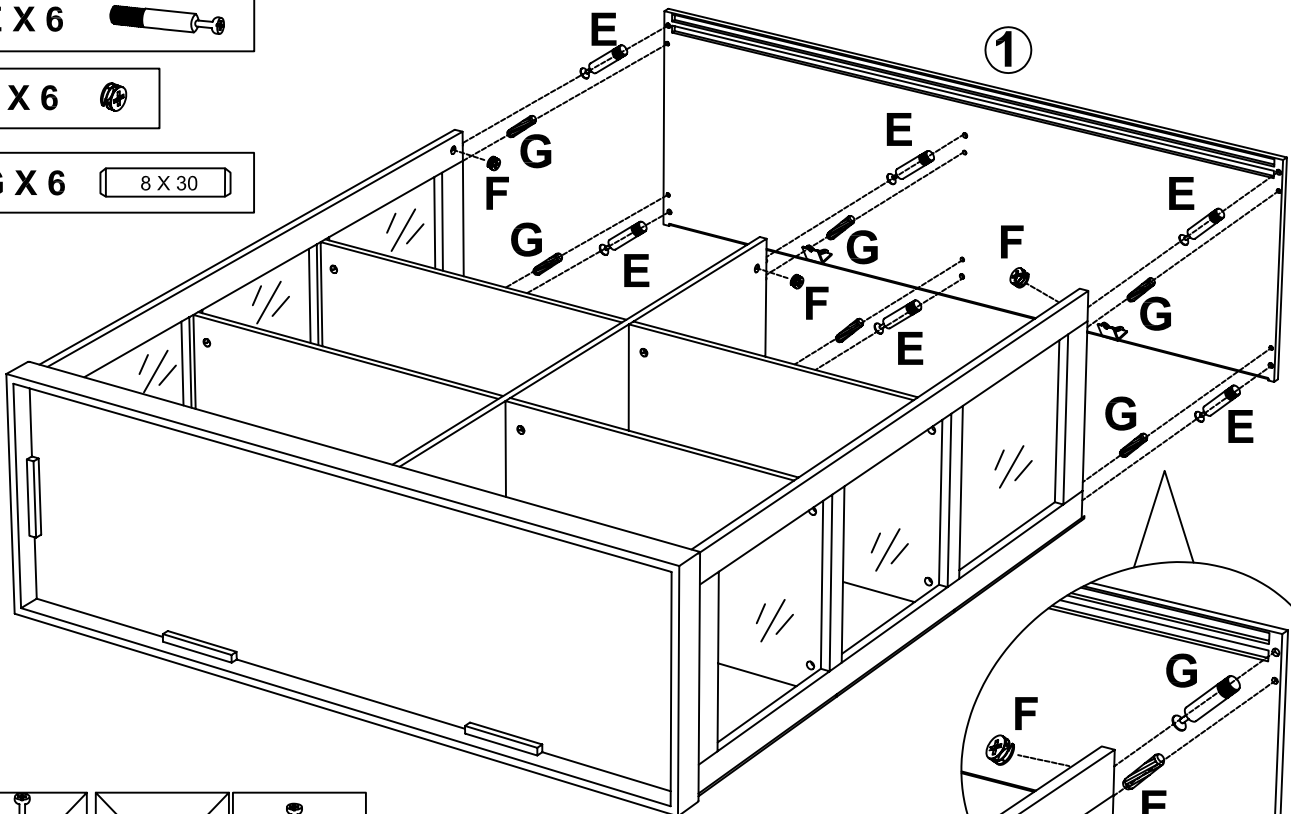

7

B X 32 ⊕ 

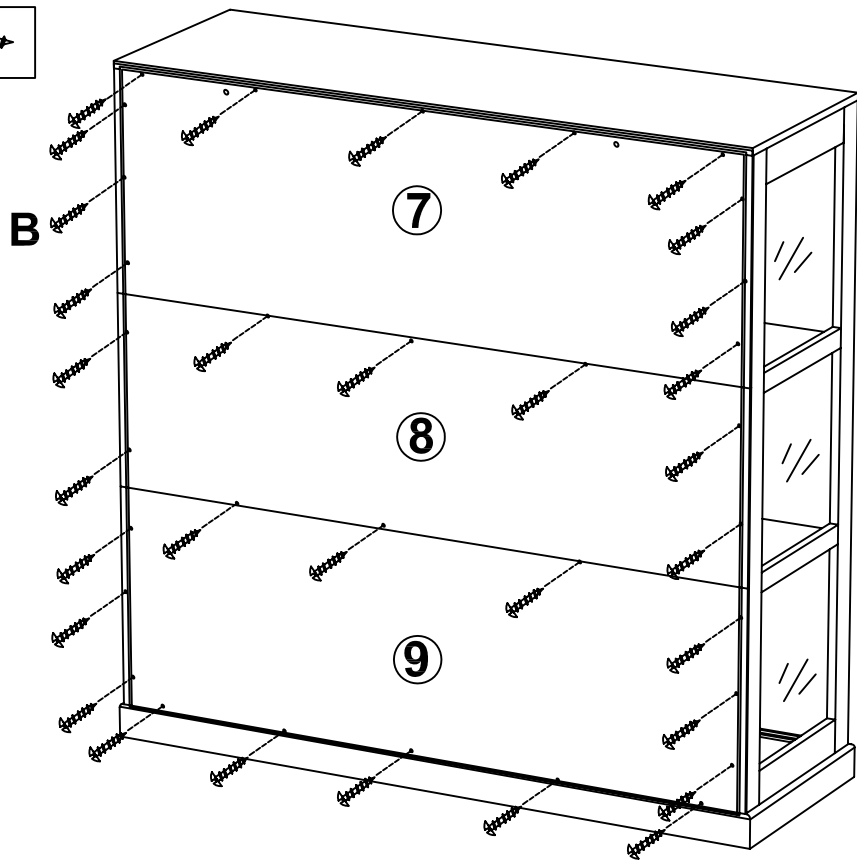

8

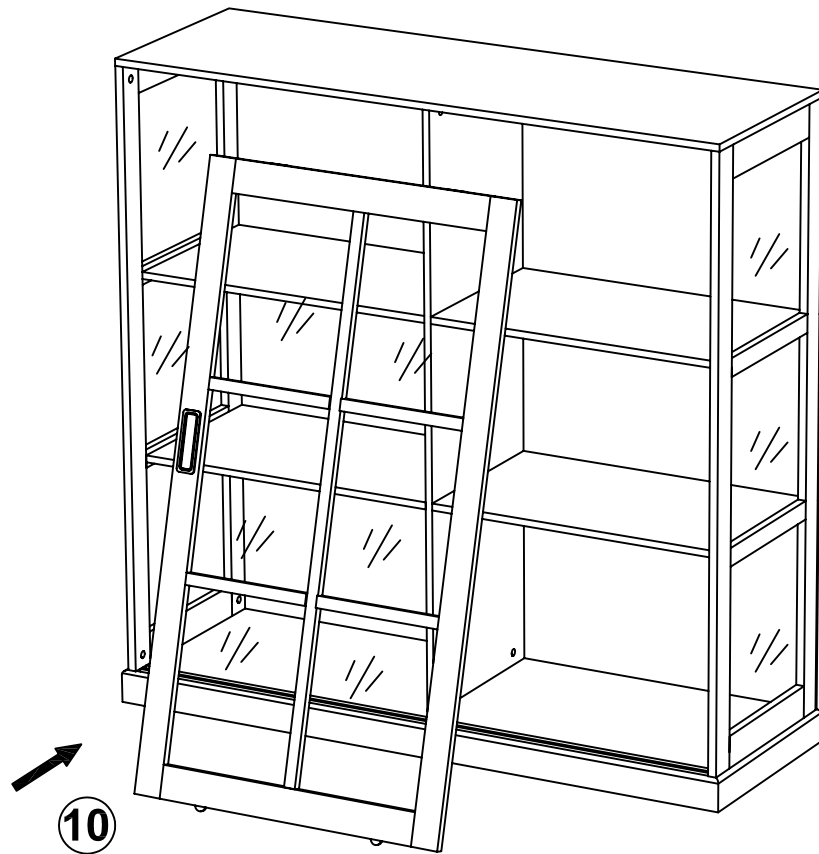

9

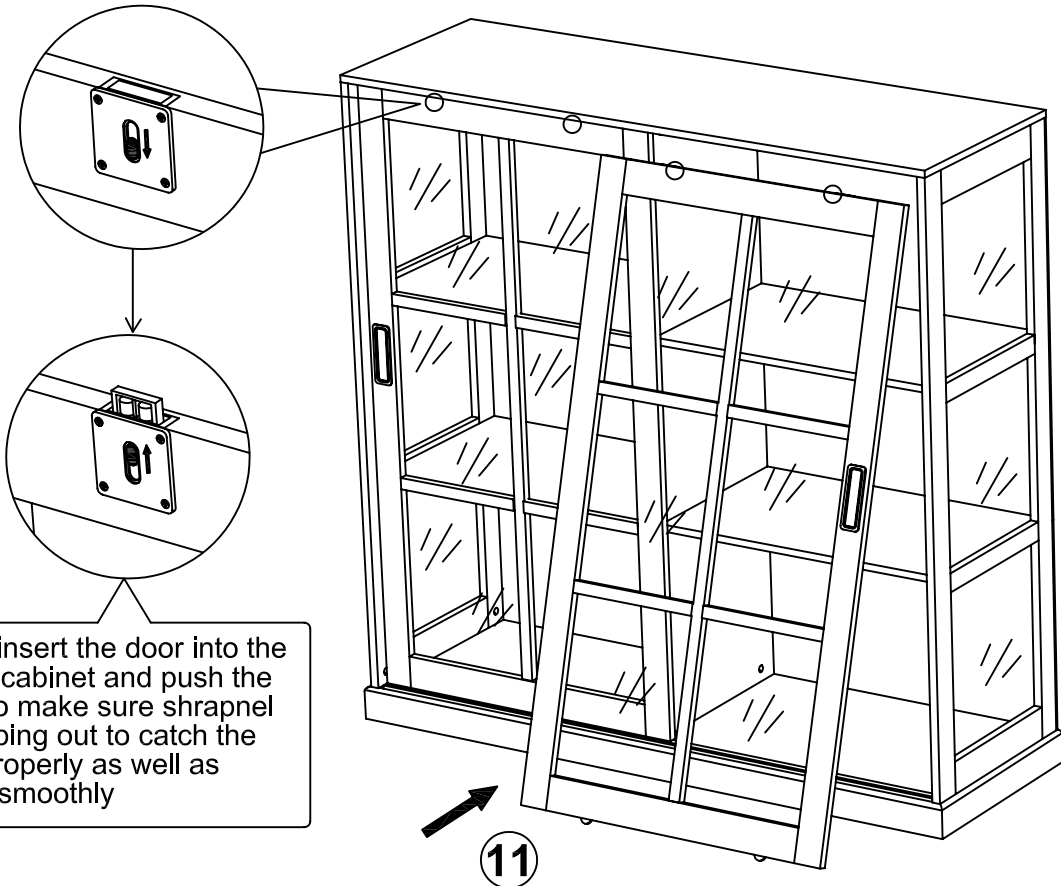

Please insert the door into the track of cabinet and push the button to make sure shrapnel will jumping out to catch the doors properly as well as moving smoothly

10

Adjustment screw for wheels up and down also keep the gap evenly between the door and cabinet it will give help on doors sliding smoothly , please work with Phillis screwdriver

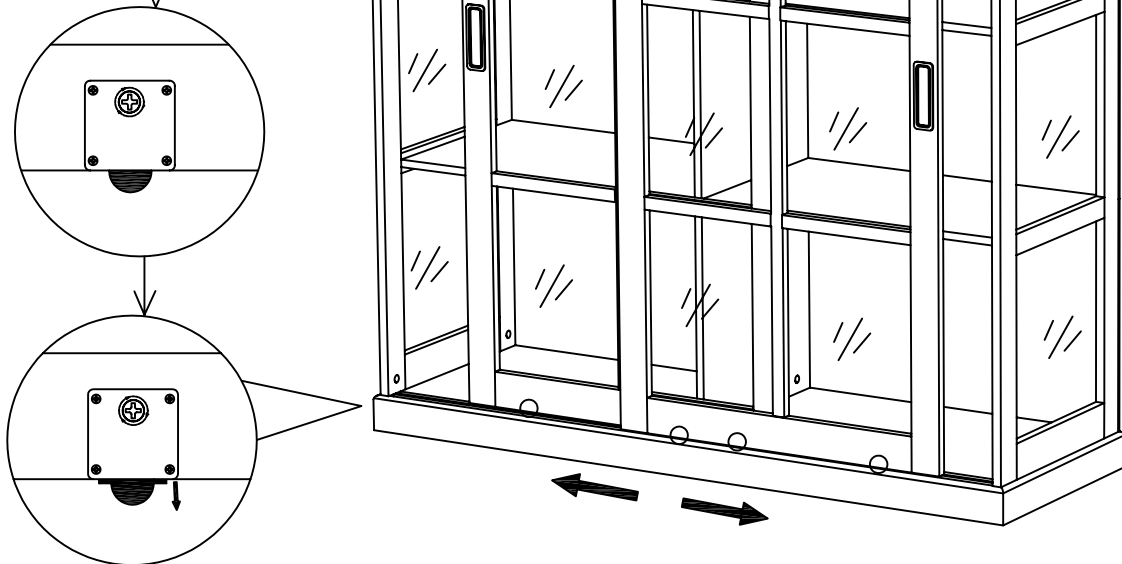

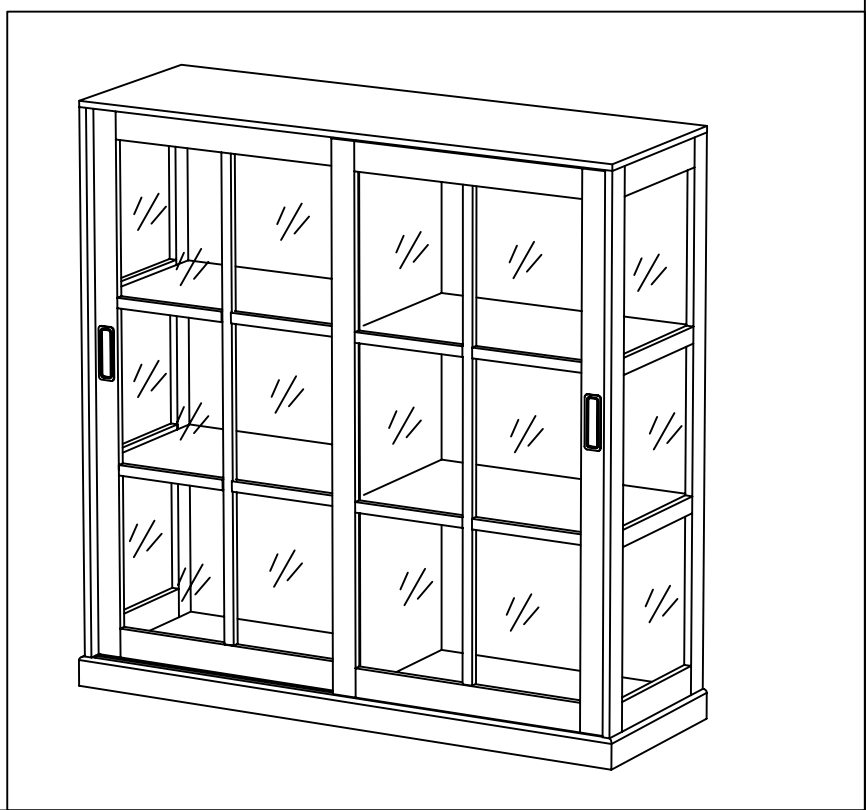
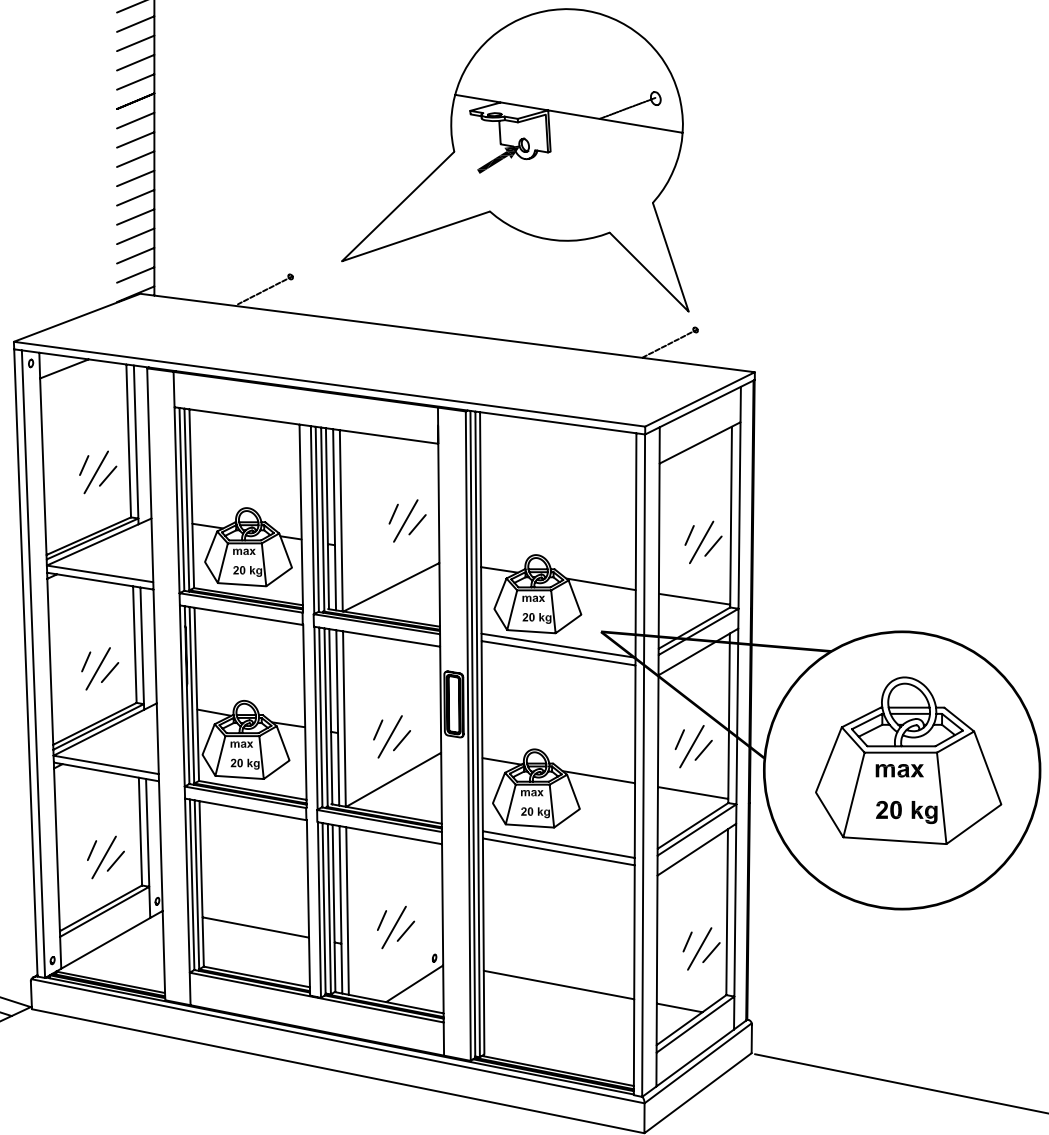





Il existe une grande diversité de types de murs ou cloisons, c'est la raison pour laquelle nous ne pouvons vous fournir le type exact de fixation. Il est nécessaire d'identifier le type de paroi à laquelle vous allez fixer ce produit afin de vous procurer les fixations appropriées. Voici quelques exemples de fixations conseillées pour :



**LES MURS PLEINS**

*CHEVILLE NYLON  
"FISCHER"*

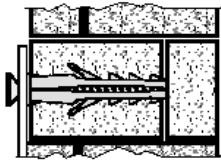
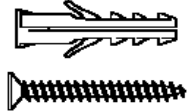

*CHEVILLE D'ANCRAGE  
MÉTAL*

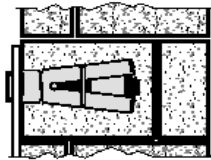
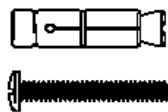

*CHEVILLE D'ANCRAGE  
A AILETTES EN NYLON*

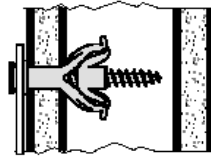
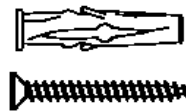

**LES CLOISONS CREUSES**

*CHEVILLE MÉTALLIQUE  
A EXPENSION*

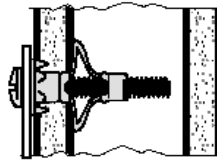
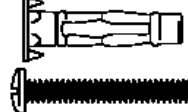

*CHEVILLE "MOLLY"*

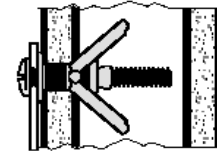
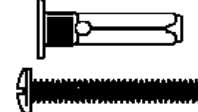

Utiliser une taille de forêt adaptée à la quincaillerie utilisée et au type de mur.



Due to the wide diversity of wall or partition types, we cannot provide you with suitable attachment fixtures . To determine which attachment fixtures to use, you will need to identify the type of wall to which you will be fixing this product. Here are some examples of attachment fixtures recommended for:

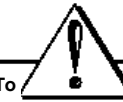

**BLIND WALLS**

*"FISCHER"  
Nylon plug*

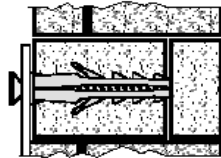
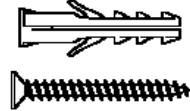

*Metal  
Wall plug*

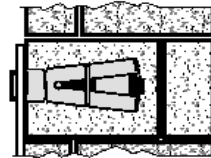
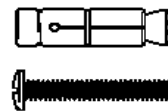

*Nylon winged  
Wall plug*

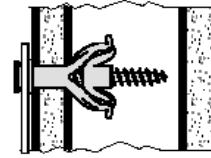
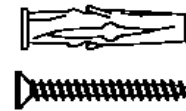

**STUDDED WALLS**

*Metal expansion  
plug*

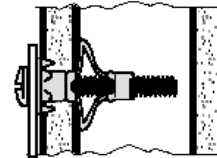
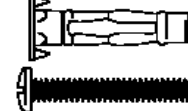

*"MOLLY" plug*

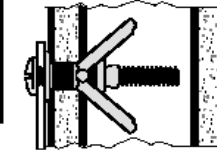
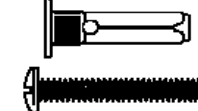

Use a drill bit that is compatible in size with the hardware used and the type of wall.



Esiste una gran varietà di tipi di muri o paratie e noi siamo in grado di fornirvi il tipo esatto di fissaggio per ognuno di essi. E' necessario identificare il tipo di parete alla quale intendete fissare questo prodotto in modo da fornirvi i fissaggi più idonei. Ecco qualche esempio di fissaggi consigliati per :



**I MURI PIENI**

**TASSELLO NYLON  
"FISCHER"**

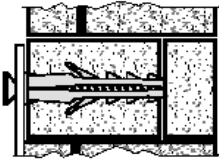
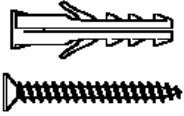

**TASSELLO DI  
ANCORAGGIO IN  
METALLO**

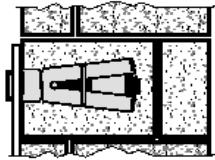
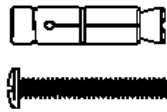

**TASSELLO DI  
ANCORAGGIO AD  
ALETTE IN NYLON**

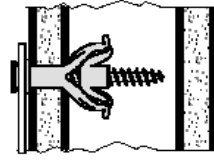
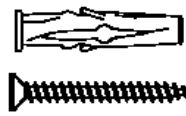

**PARATIE CAVE  
TASSELLO METALLICO  
AD ESPANSIONE**

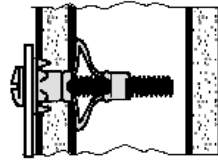
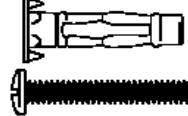

**TASSELLO  
"MOLLY"**

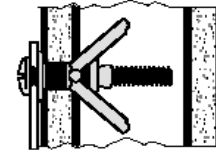
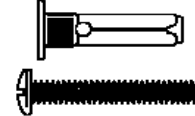

Utilizzare una punta di trapano adatta agli utensili utilizzati e al tipo di muro.



Es gibt eine Vielzahl verschiedener Arten von Mauern oder Zwischenwänden, und aus diesem Grunde können wir Ihnen den genau entsprechenden Befestigungstyp nicht bereitstellen. Zunächst ist es erforderlich, die exakte Bauart der Wand zu ermitteln, an der Sie dieses Produkt anbringen werden, um die für diese Wand geeigneten Befestigungsmittel im Fachhandel erwerben zu können. Nachfolgend einige Beispiele empfohlener Befestigungen für:



**VOLLWÄNDE**

**NYLONDÜBEL  
„FISCHER“**

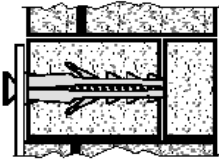
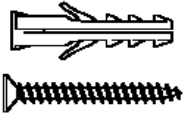

**ANKERDÜBEL  
AUS METALL**

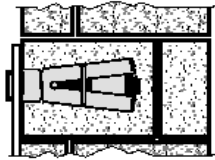
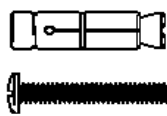

**ANKERDÜBEL MIT  
NYLONFLÜGELN**

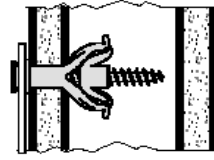
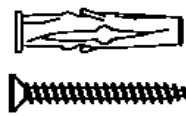

**HOHLWÄNDE  
SPREIZDÜBEL FÜR  
VERANKERUNG AUS METALL**

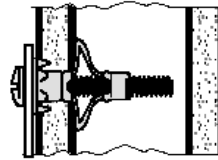
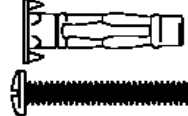

**MOLLY-DÜBEL**

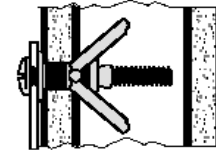
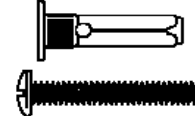

Bitte verwenden Sie eine für die Eisenwaren und den Wandtyp geeignete Bohrergröße.