

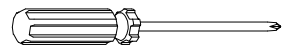

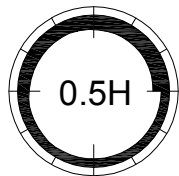

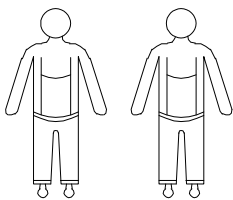

Seaford

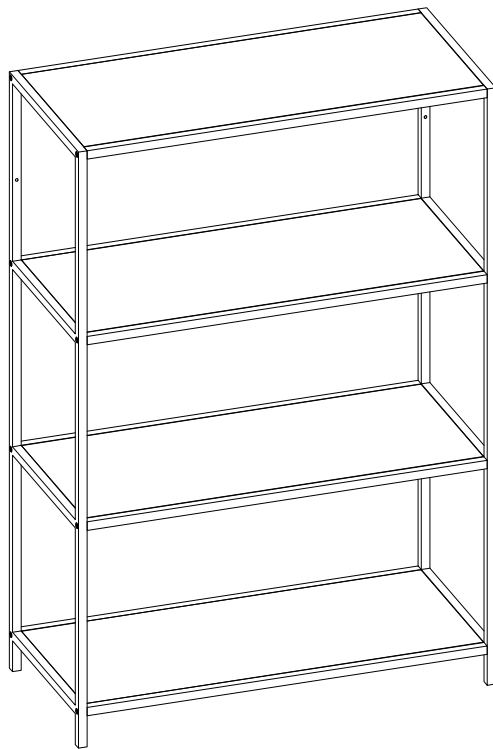
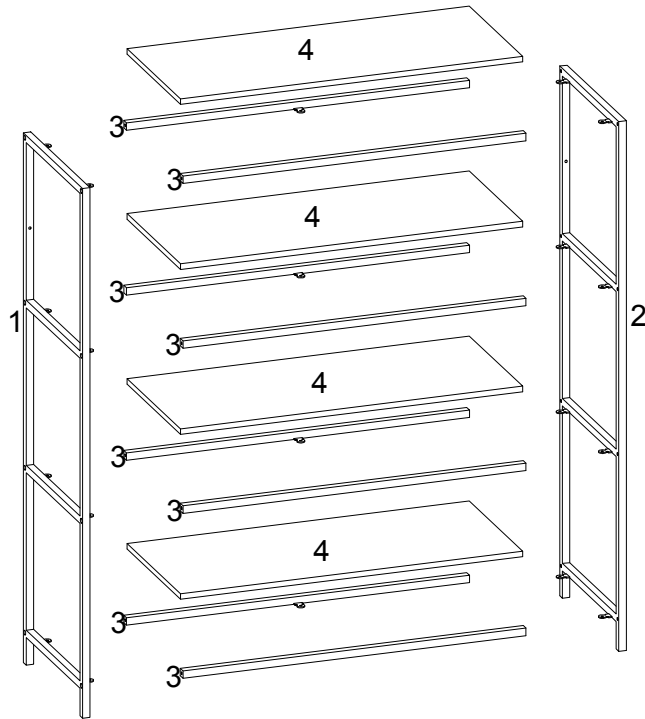



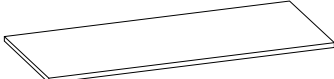
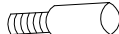

<p>1</p>  <p>1PC</p>	<p>2</p>  <p>1PC</p>
<p>3</p>  <p>8PCS</p>	<p>4</p>  <p>4PCS</p>

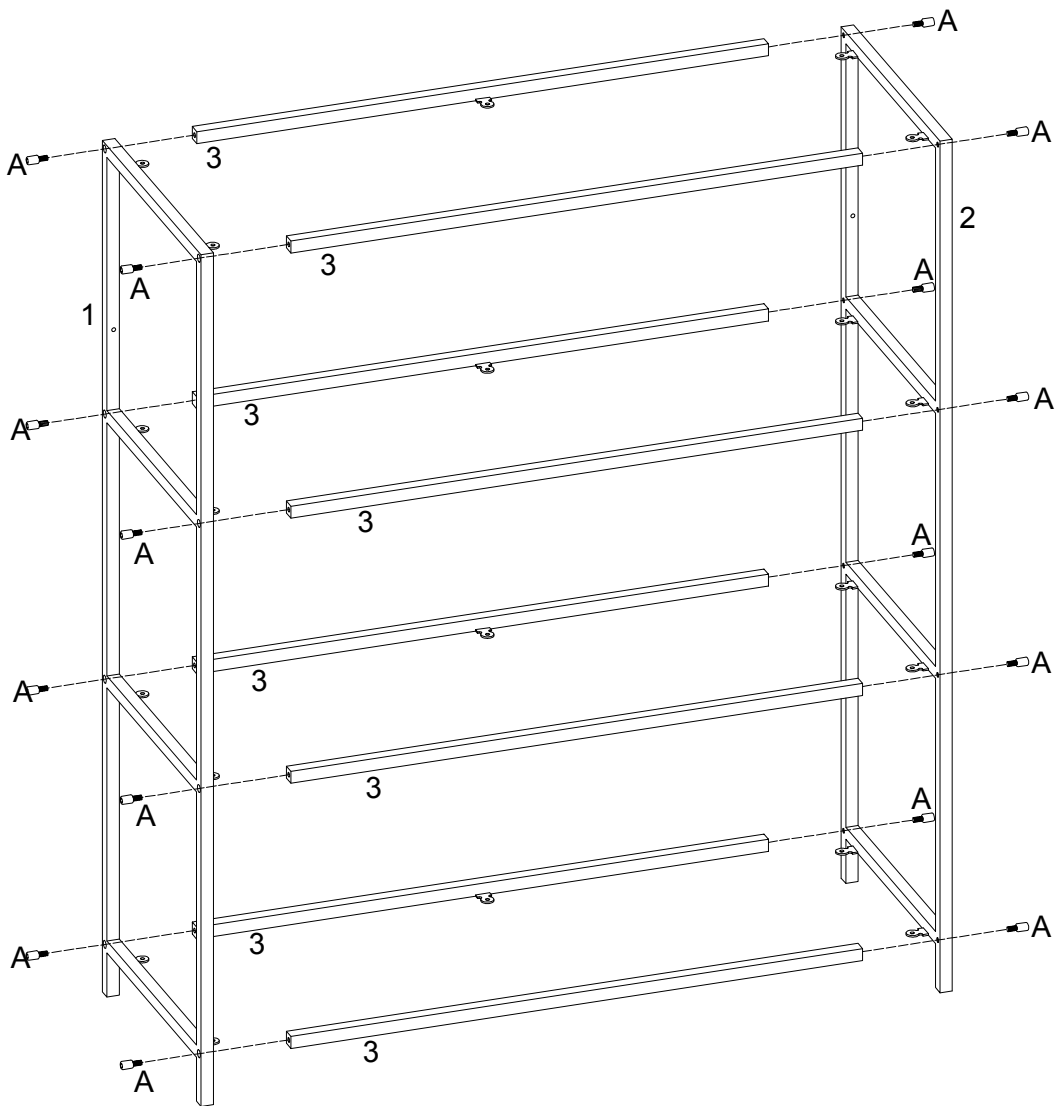
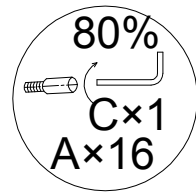
<p>A</p> <p>M6×15mm</p>  <p>16PCS</p>	<p>B</p> <p>M4×12mm</p>  <p>24PCS</p>	<p>C</p> <p>4mm</p>  <p>1PC</p>
--	--	--



<p>A</p> <p>M6×15mm</p>  <p>16PCS</p>	<p>C</p> <p>4mm</p>  <p>1PC</p>
---	---

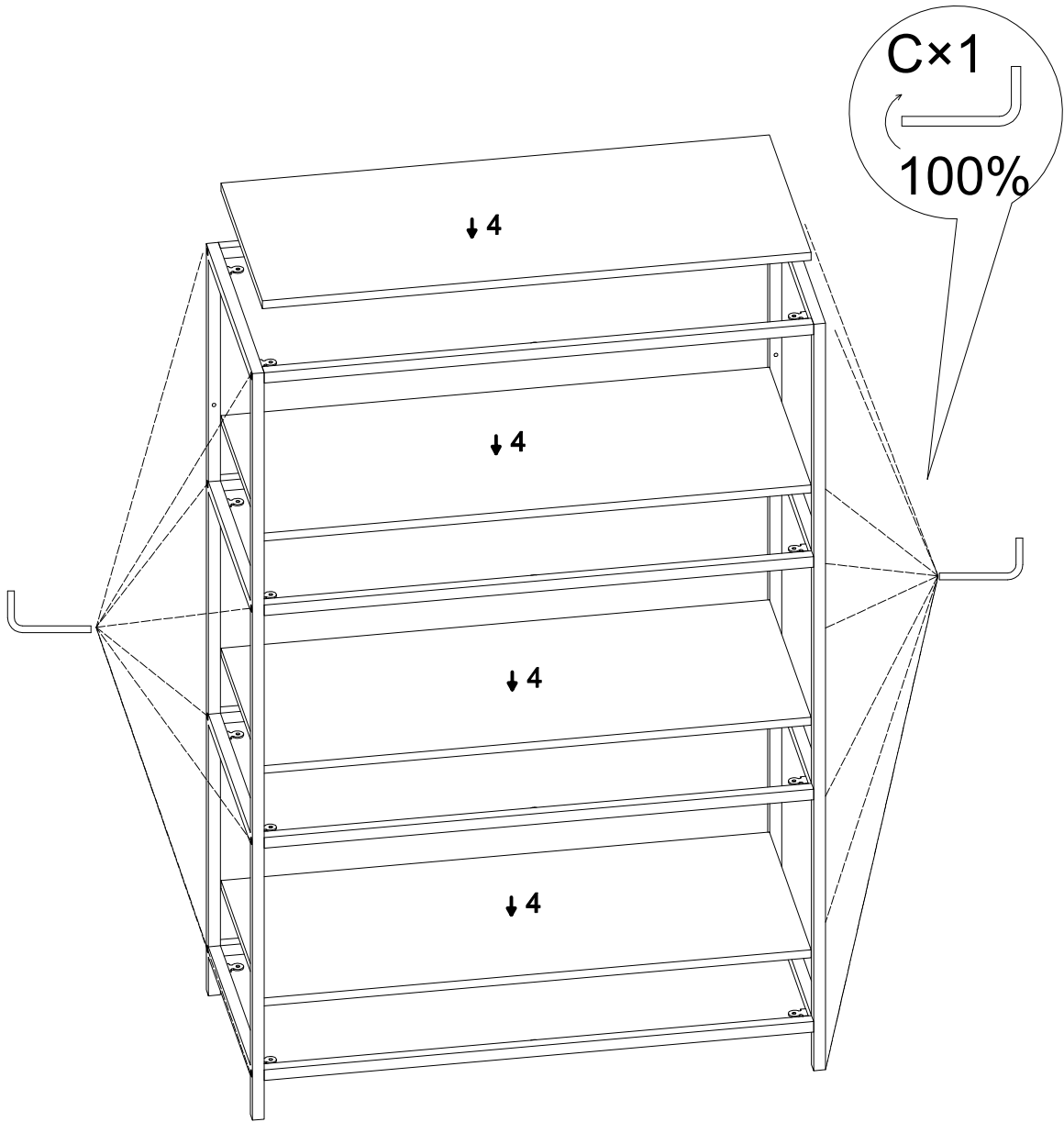

! XX=YY

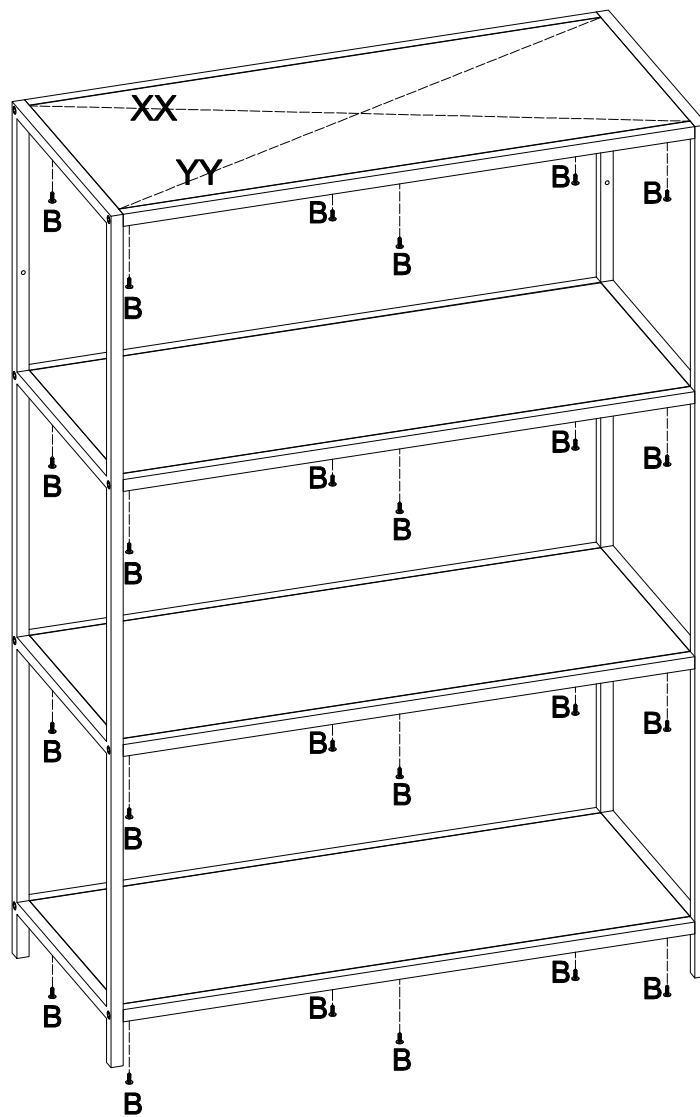

B
M4×12mm

24PCS

