

Belina

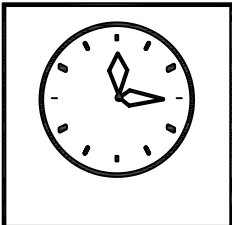

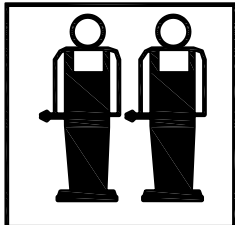

1 x 1

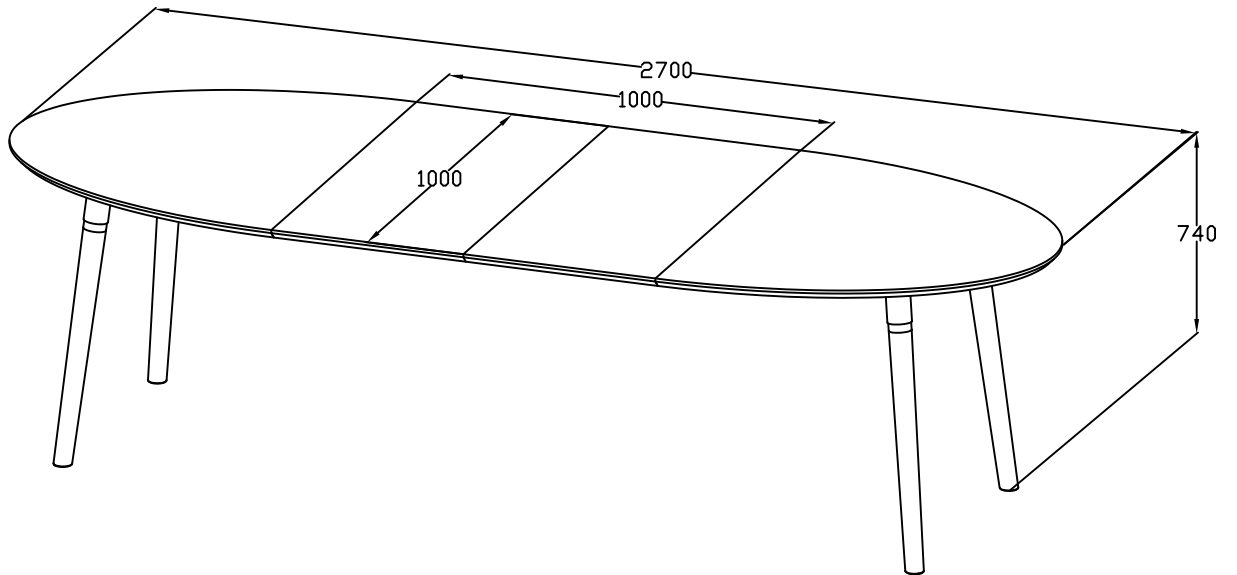
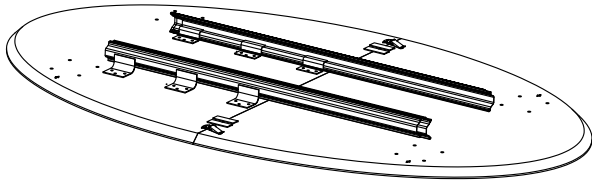
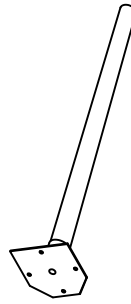

2 x 4

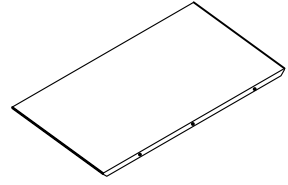

3 x 2

$\frac{1}{4}$ " x 15mm

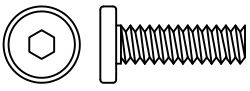

A x 16



B x 16



C x 1

