

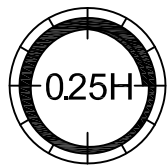

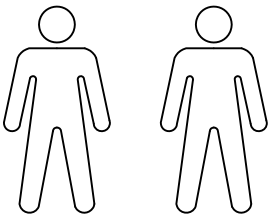

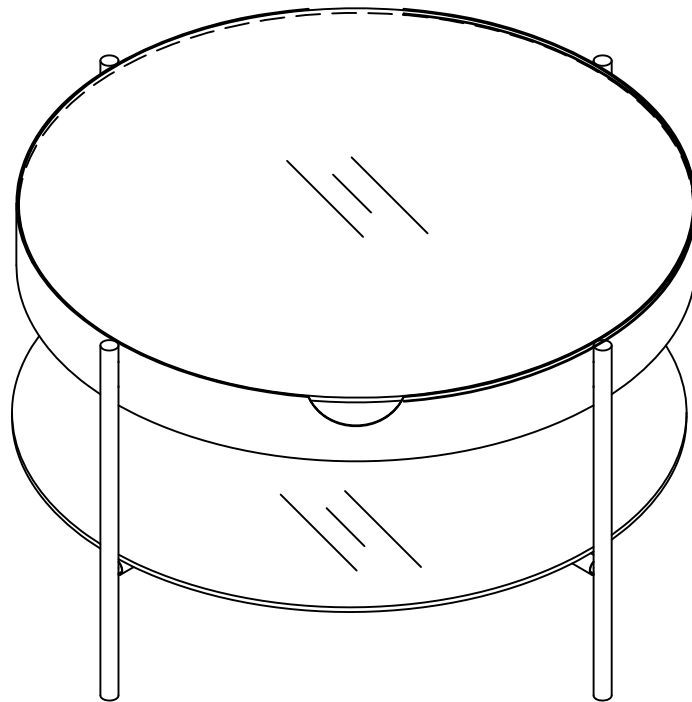

TIPTON - tray table

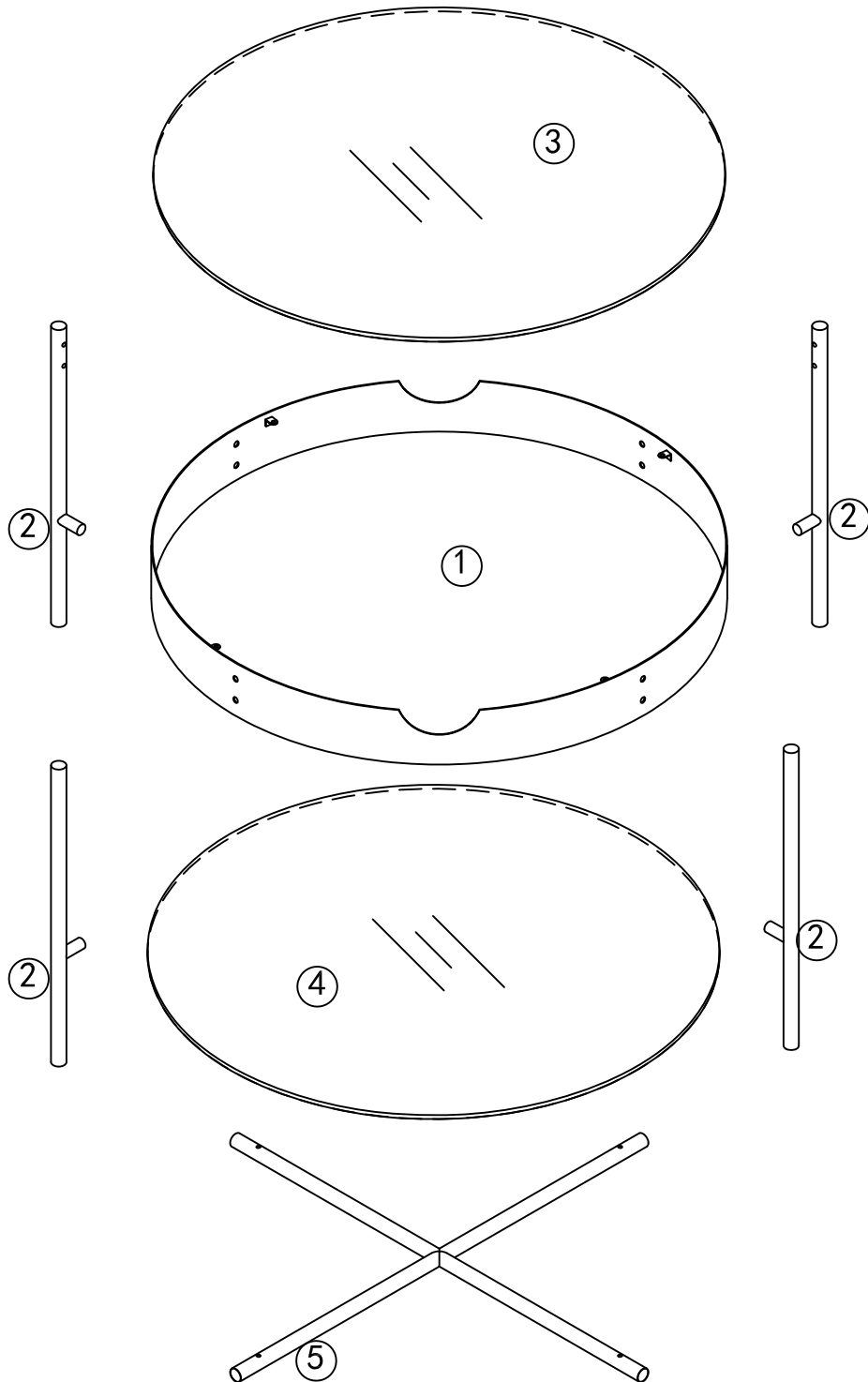



			✓
①	1	Φ713x80	
②	4	450x54x19	
③	1	Φ705x6	
④	1	Φ709x6	
⑤	1	720x720x19	





<p>Ax4</p>  <p>M6x12mm</p>	<p>Bx8</p>  <p>M6x12mm</p>	<p>Cx8</p>  <p>Φ6/Φ15</p>	<p>Dx4</p>  <p>Φ20</p>	<p>Ex4</p>  <p>Φ13x3mm</p>
<p>Fx1</p>  <p>4mm</p>				

1

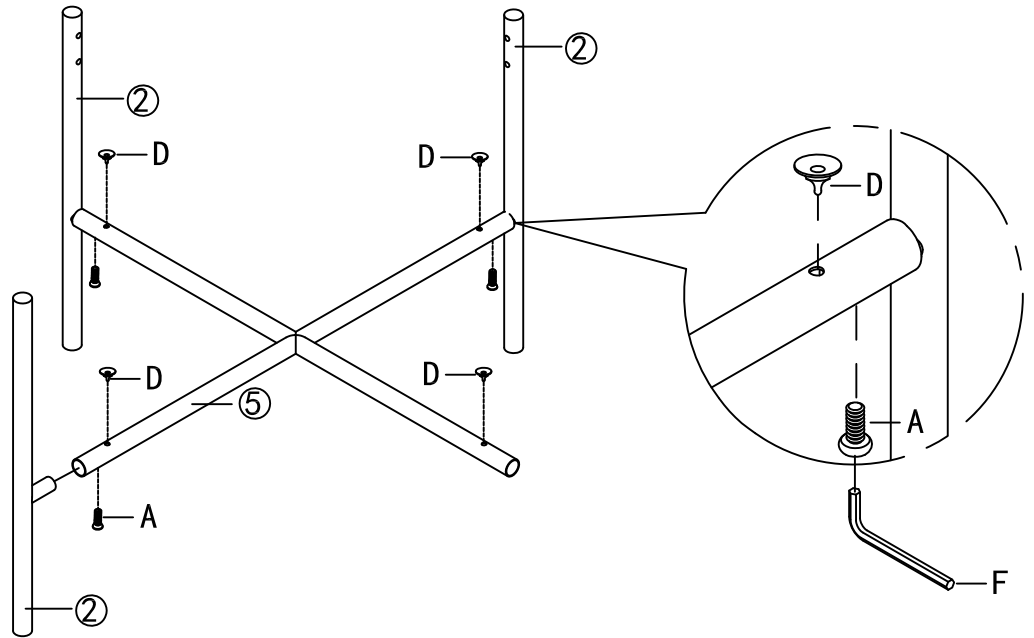
Ax3  M6x12mm	Dx4  Φ20	Fx1  4mm
---	---	---



2



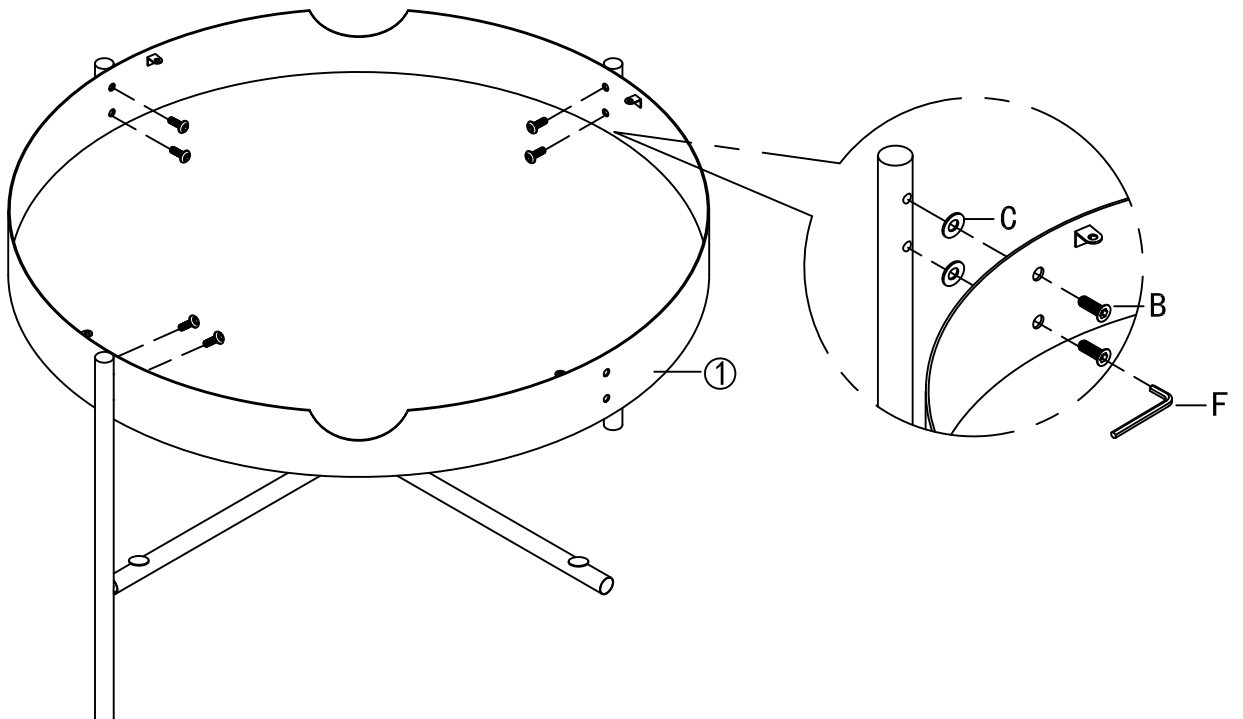

Bx6  M6x12mm	Cx6  Φ6/Φ15	Fx1  4mm
---	--	---

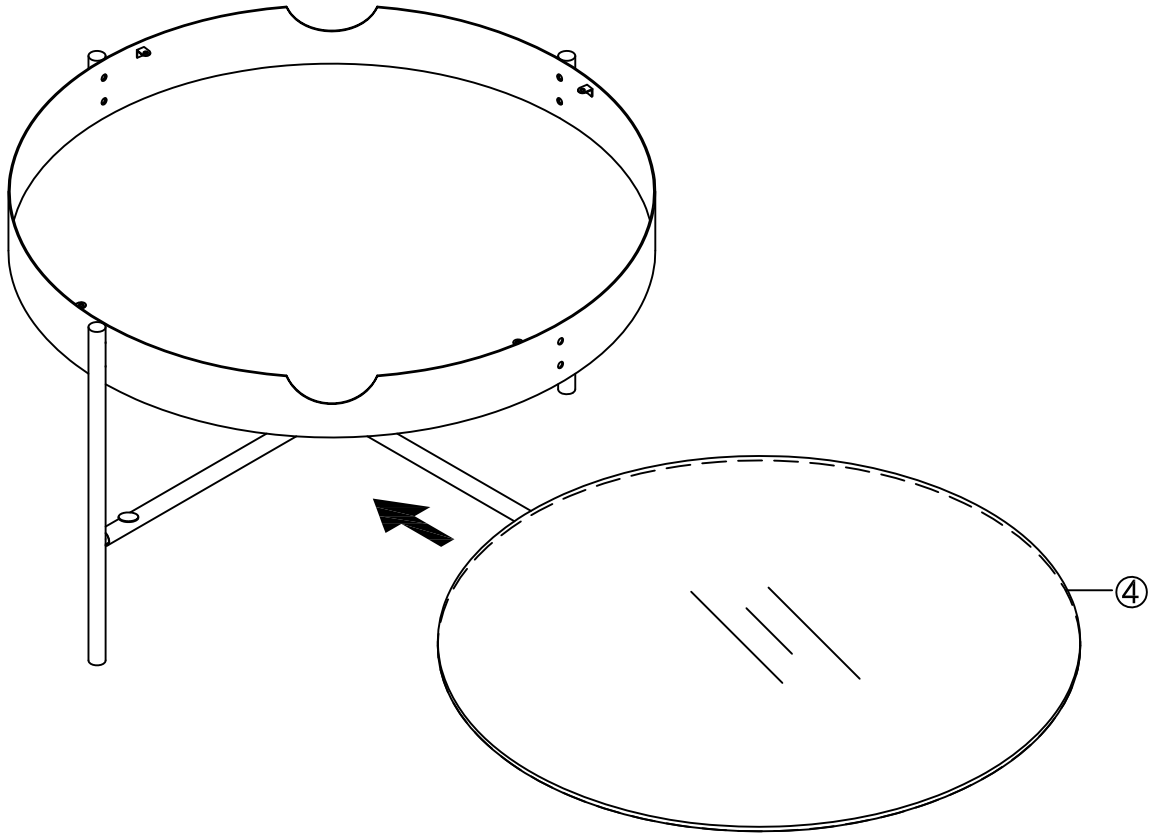

3



4

Ax1  M6x12mm	Bx2  M6x12mm	Cx2  Φ6/Φ15	Fx1  4mm
---	---	--	---

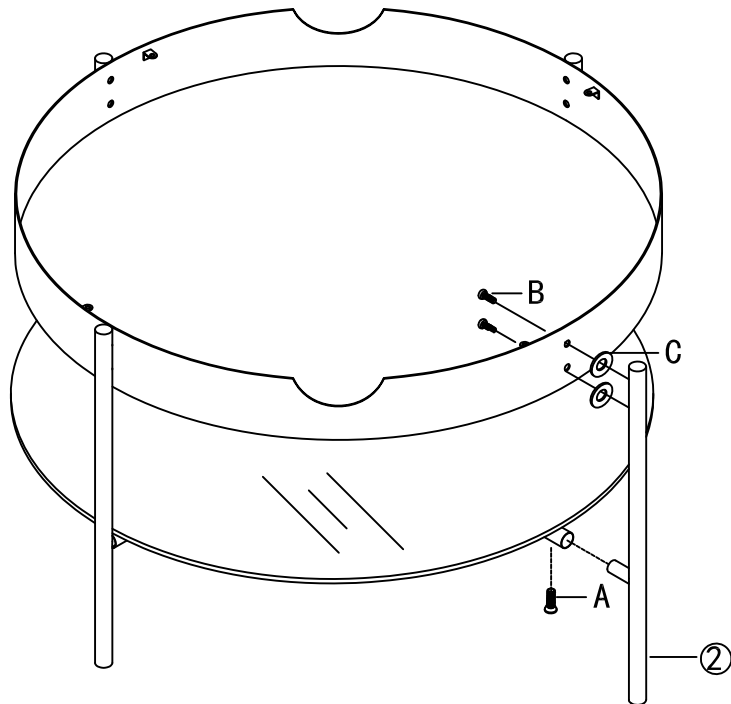

5

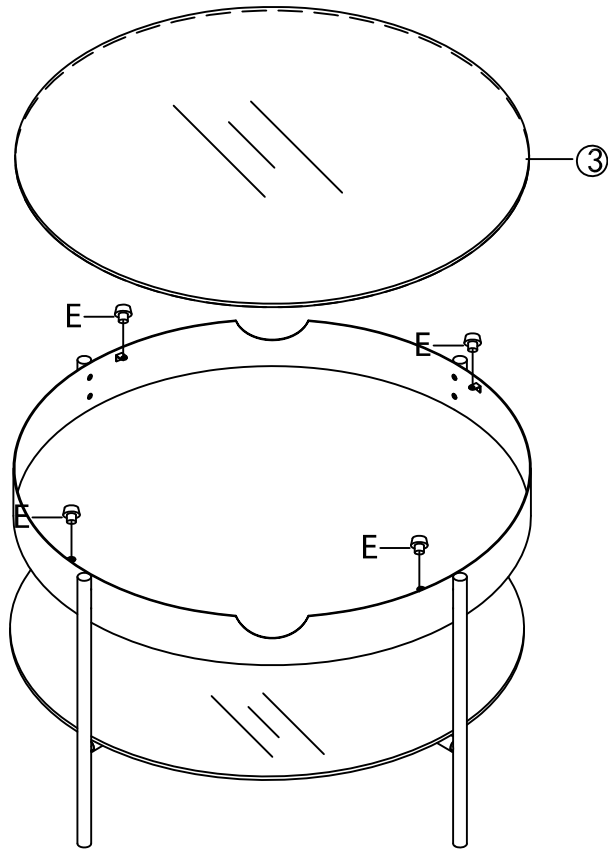
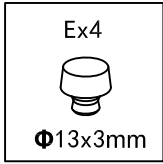

6

