

# Step 1

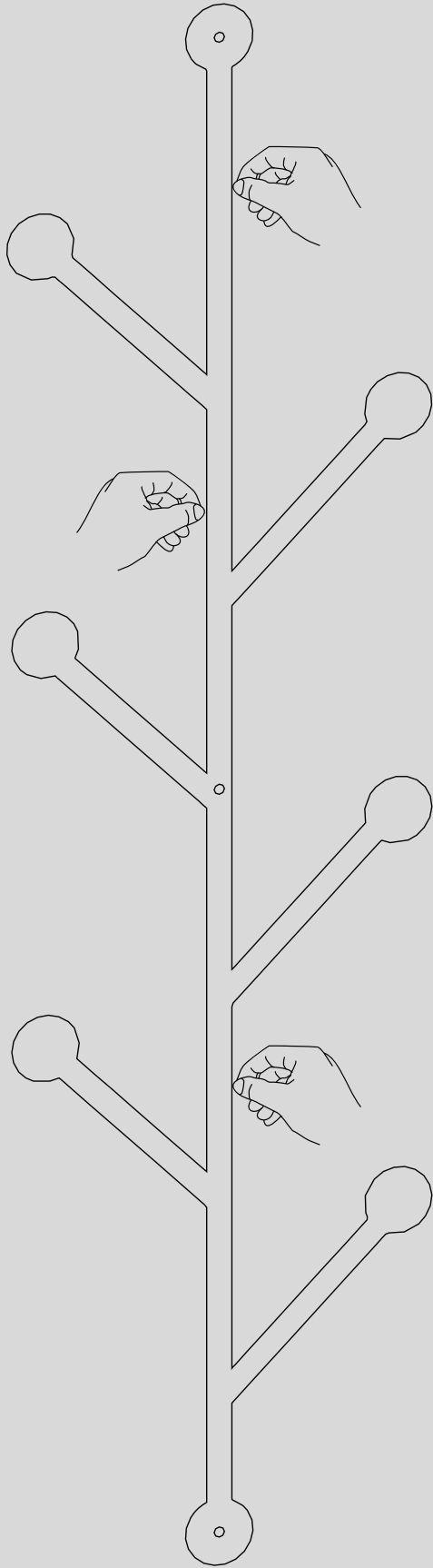

**Hold the product in a fixed position on the wall.  
Mark the center of the hole with a pen.**

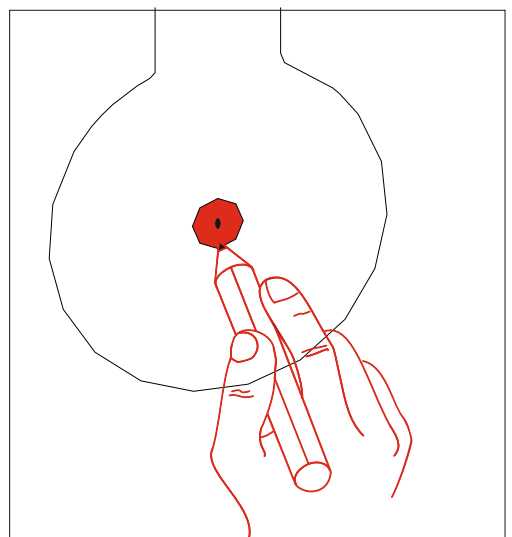
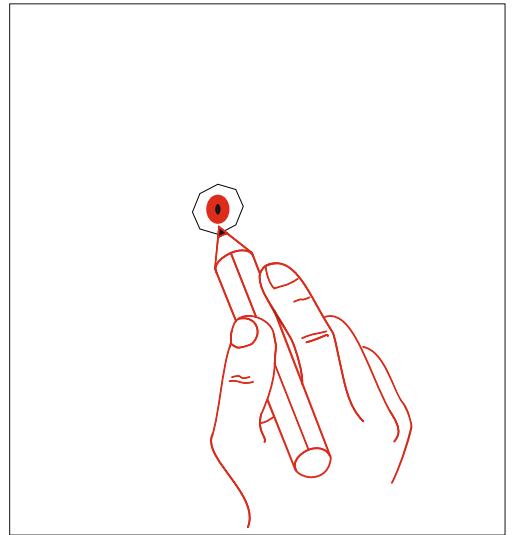
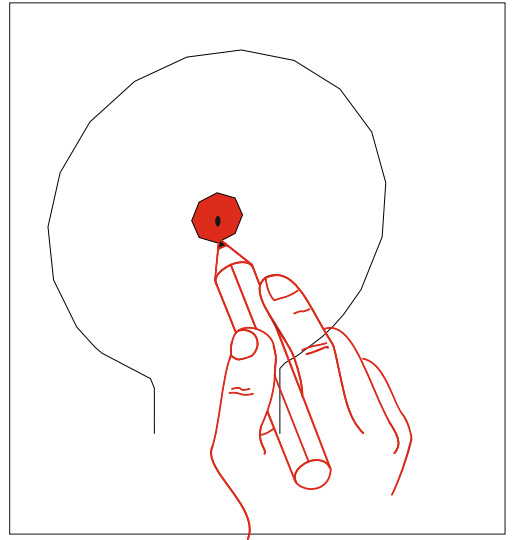

# Step 2

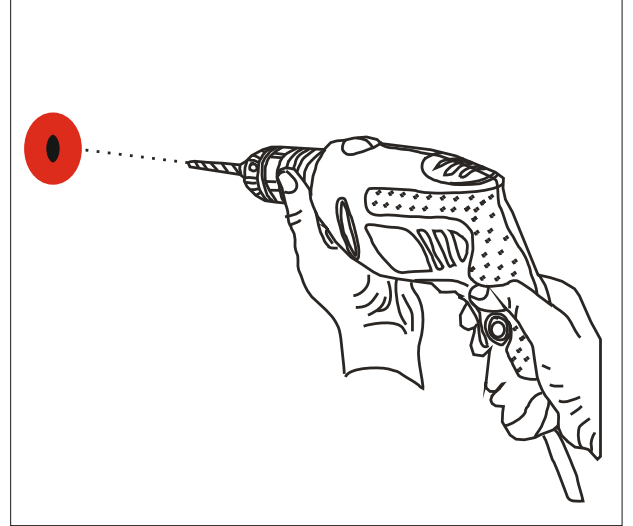
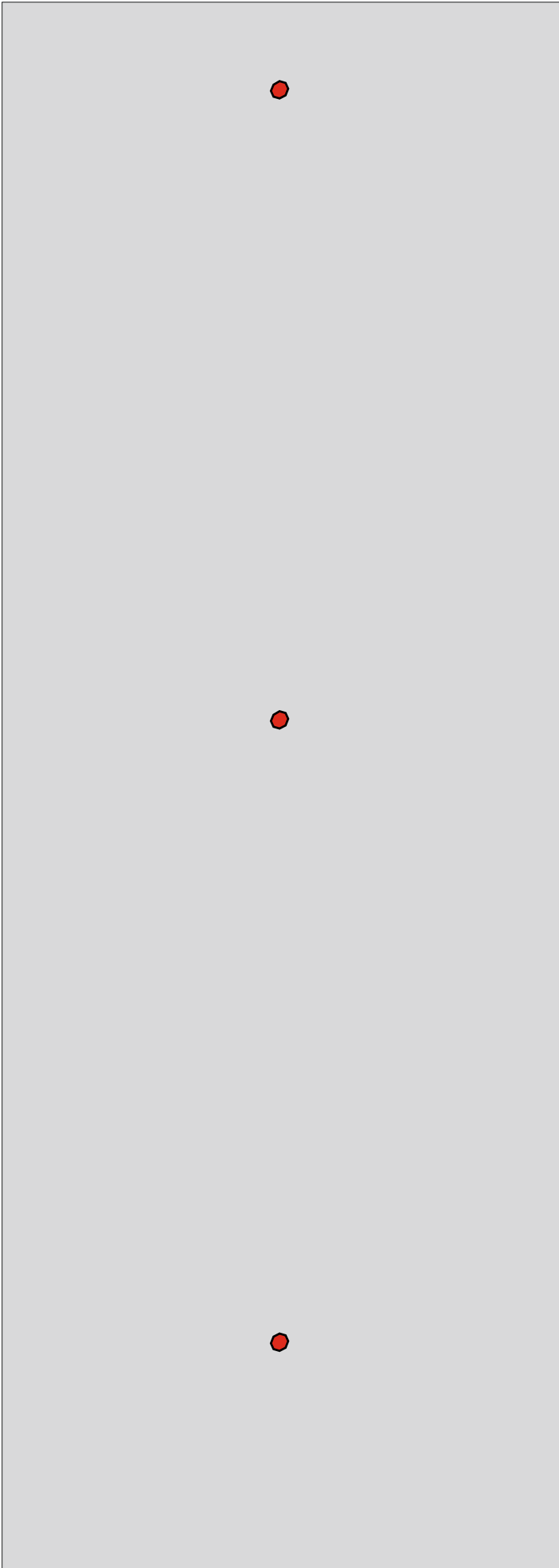

Drill the marked locations with a drill

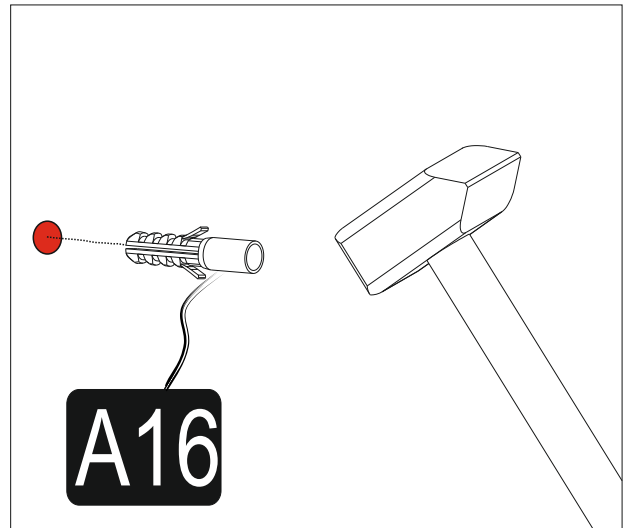

Attach the plugs to the drilled places.

# Step 3

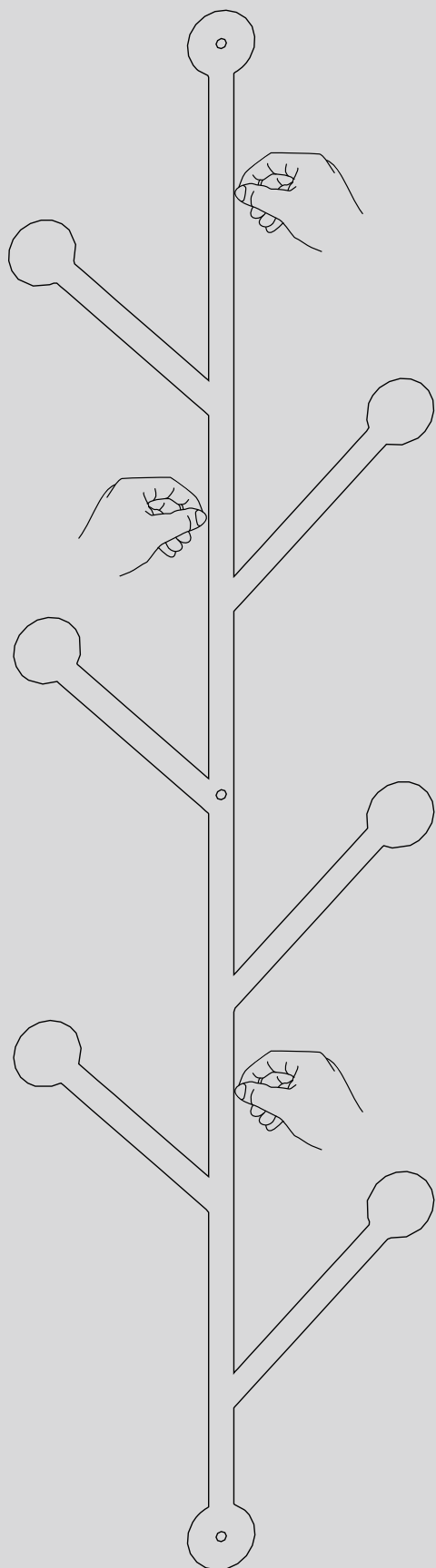

Align the product again on the wall and connect with the specified screw.

