

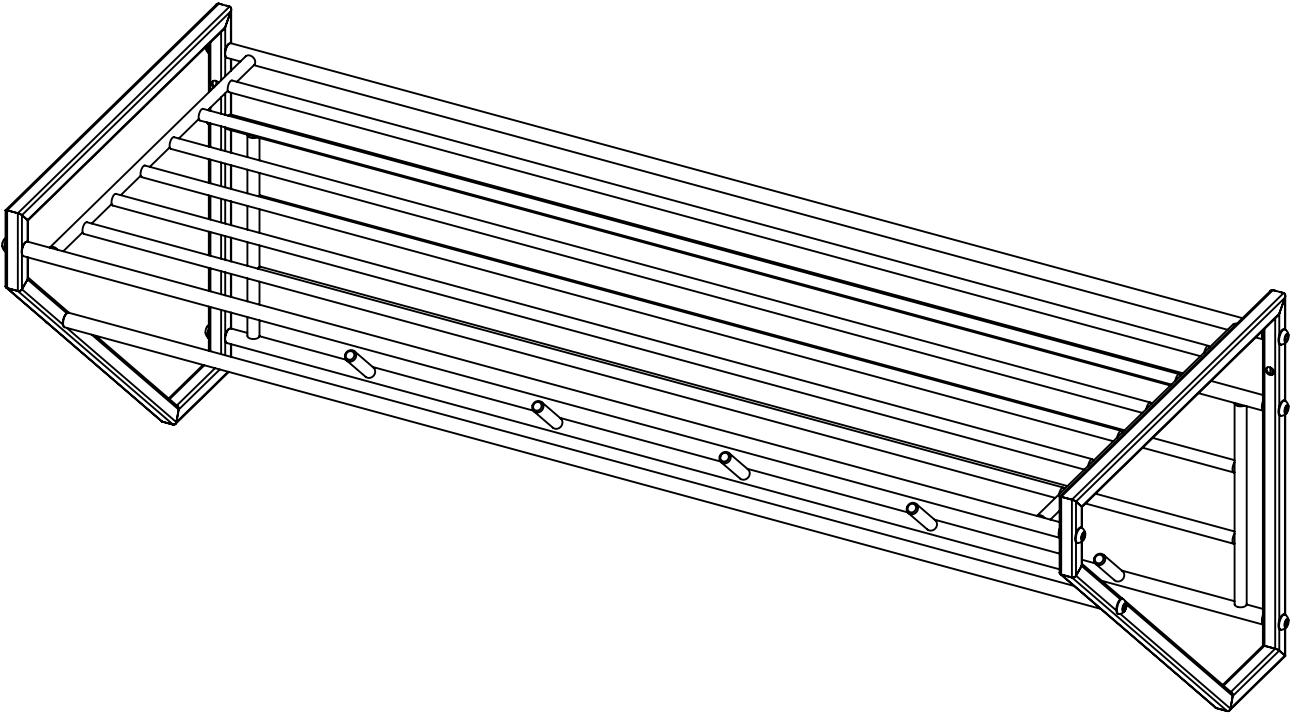



**Assembly Instruction**  
**1667415-01-0, 1667415-02-0**

**Jotex**

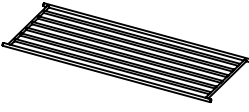
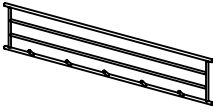
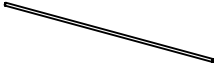

1.	2.	3.	4.	5.	6.	7.	8.
				 M6x20	 4mm		
2x	1x	1x	1x	10x	1x	2x	2x

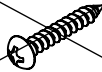
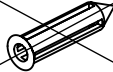
**Assembly Instruction**  
**1667415-01-0, 1667415-02-0**

**Jotex**

1.

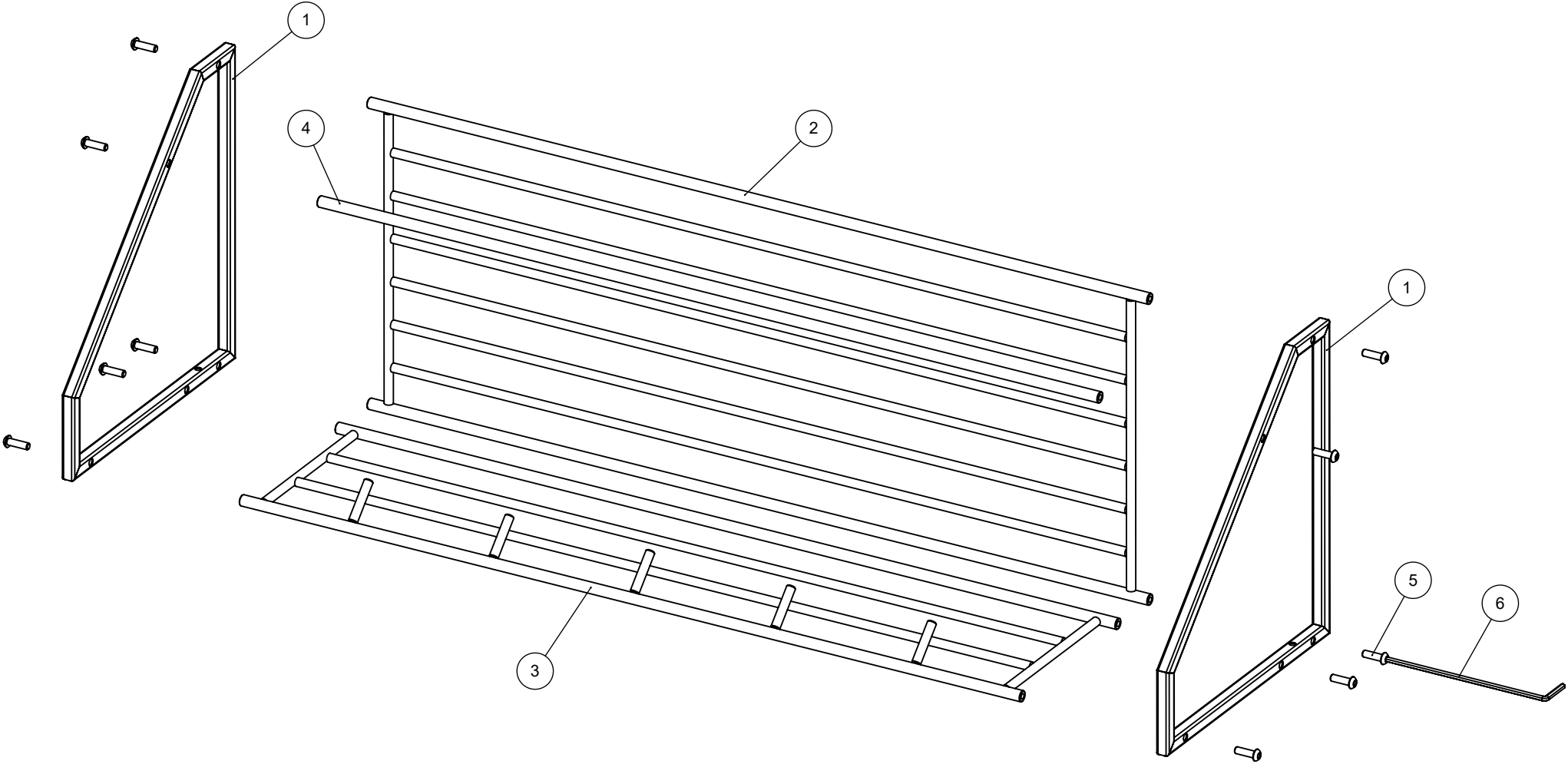

# Assembly Instruction 1667415-01-0, 1667415-02-0

2.

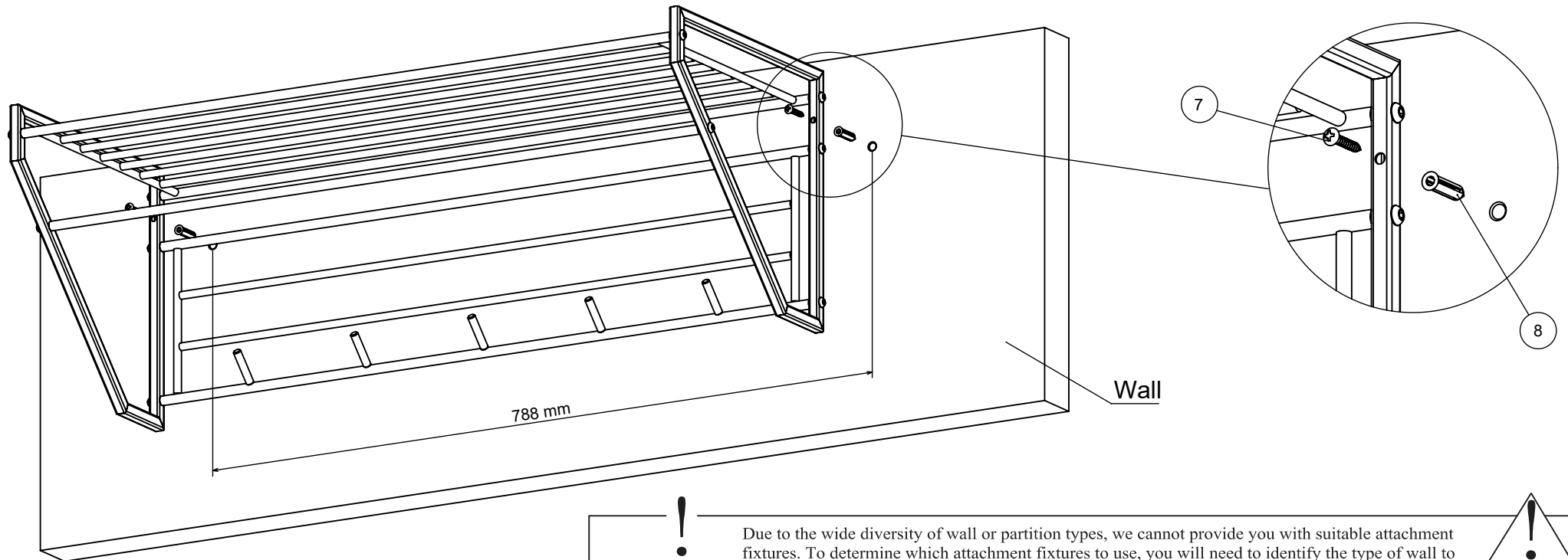

Due to the wide diversity of wall or partition types, we cannot provide you with suitable attachment fixtures. To determine which attachment fixtures to use, you will need to identify the type of wall to which you will be fixing this product. Here are some examples of attachment fixtures recommended for :

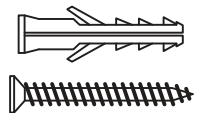
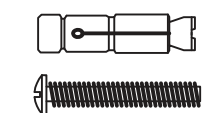
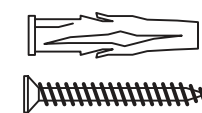
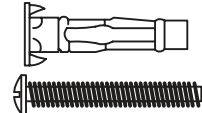
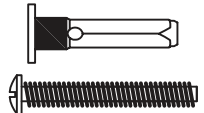
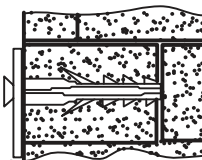
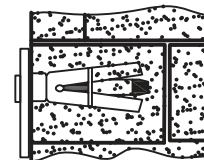
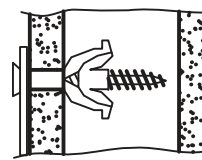
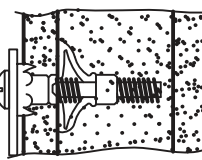
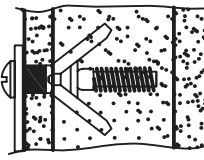

BLIND WALLS		STUDDED WALLS		
<p>"FISCHER" Nylon plug</p> 	<p>Metal Wall plug</p> 	<p>Nylon winged Wall plug</p> 	<p>Metal expansion plug</p> 	<p>"MOLLY" plug</p> 
				



Use a drill bit that is compatible in size with the hardware used and the type of wall