

Assembly Instruction
1667418-01-0, 1667418-02-0

Jotex

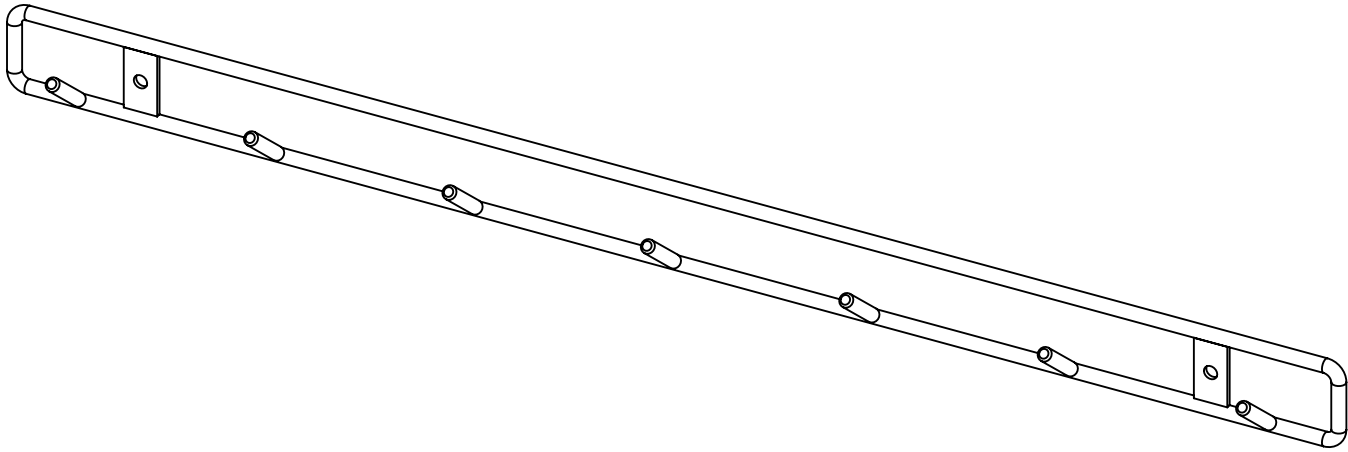
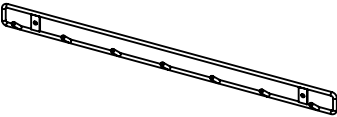
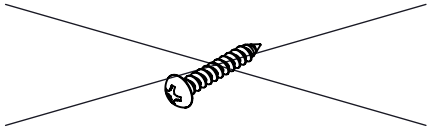
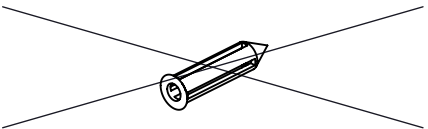

| 1. | 2. | 3. |
|---|---|--|
|  |  |  |
| 1x | 2x | 2x |

Assembly Instruction 1667418-01-0, 1667418-02-0

Jotex

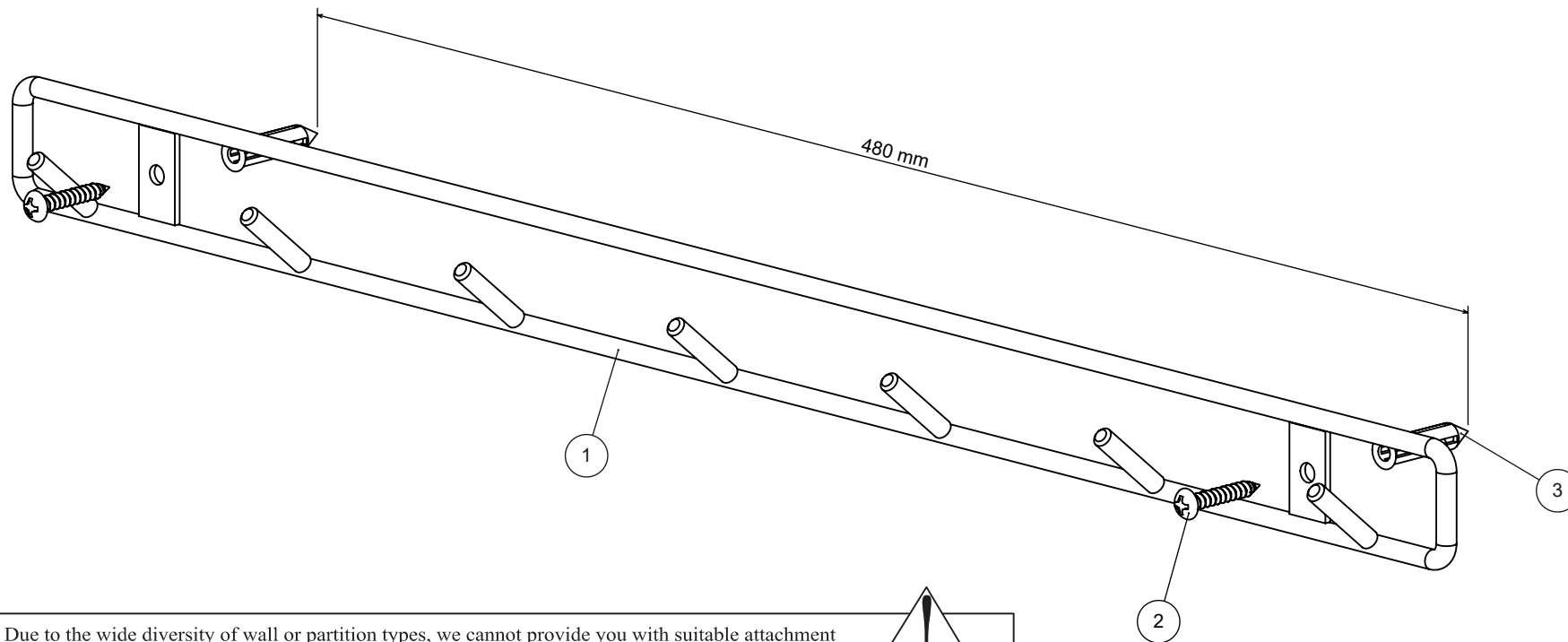

Due to the wide diversity of wall or partition types, we cannot provide you with suitable attachment fixtures. To determine which attachment fixtures to use, you will need to identify the type of wall to which you will be fixing this product. Here are some examples of attachment fixtures recommended for :



BLIND WALLS

"FISCHER"
Nylon plug

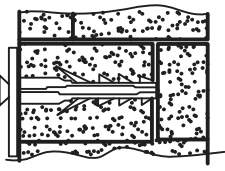
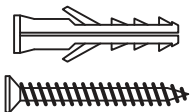

Metal
Wall plug

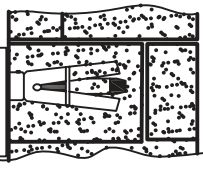
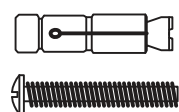

STUDDED WALLS

Nylon winged
Wall plug

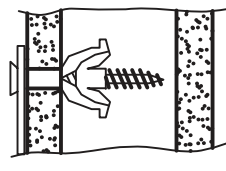
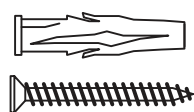

Metal expansion
plug

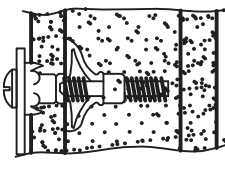
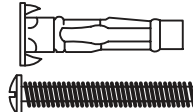

"MOLLY" plug

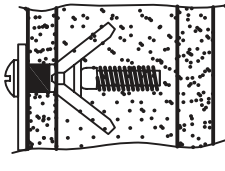
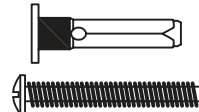

Use a drill bit that is compatible in size with the hardware used and the type of wall