

Infrared Patio Heater

Safety Instructions and Operation Manual

1675332-01-0

- 1. This appliance can be used by children aged from 8 years and above and persons with reduced physical, sensory or mental capabilities or lack of experience and knowledge if they have been given supervision or instruction concerning use of the appliance in a safe way and understand the hazards involved. Children shall not play with the appliance. Cleaning and user maintenance shall not be made by children without supervision.**
- 2. If the supply cord is damaged, it must be replaced by the manufacturer, its service**

agent or similarly qualified persons in order to avoid a hazard.

- 3. Children of less than 3 years should be kept away unless continuously supervised.**
- 4. Children aged from 3 years and less than 8 years shall only switch on/off the appliance provided that it has been placed or installed in its intended normal operating position and they have been given supervision or instruction concerning use of the appliance in a safe way and understand the hazards involved. Children aged from 3 years and less than 8 years shall not plug in, regulate and clean the appliance or perform user maintenance.**
- 5. CAUTION — Some parts of this product can become very hot and cause burns. Particular attention has**

to be given where children and vulnerable people are present.

- 6. The heater must not be located immediately below a socket-outlet.**
- 7. The Installation of the heater should not be close to curtains and other combustibile materials**
- 8. Do not use this heater with a programmer, timer, separate remote-control system or any other device that switches the heater on automatically, since a fire risk exists if the heater is covered or positioned incorrectly.**
- 9. Do not use this heater in the immediate surroundings of a bath, a shower or a swimming pool.**

Brief Introduction

This product is infrared radiant heater with remote control and IP 65 approved .It is almost unlimited used in outdoor ,such as open bars, courtyard, plaza, station in winter etc. This patio heater is energy-efficient, convenient, environmentally friendly and for better life etc.

Important Safety Instructions

When using electrical appliances, basic safety precautions should always be followed to reduce the risk of fire, electric shock, or injury to persons, including the following:.

Read all instructions before using this heater

This heater is hot when in use .To avoid burns,do not let bare skin touch hot surfaces.If provided ,use handles when moving this heater.Keep combustible materials,such as furniture, pillows ,bedding ,papers,clothes and curtains at least 0.9m from the front of the heater.

- Extreme caution is necessary when any heater is used by or near children or invalids and whenever the heater is left operating and unattended.
- Always unplug heater when not in use
- Do not run cord under carpeting. Do not cover cord with throw rugs, runners, or similar coverings. Do not route cord under furniture or appliances. Arrange cord away from

traffic area and where it will not be tripped over.

- Connect to properly grounded outlets only.
- To disconnect heater, turn controls off, then remove plug from outlet.
- Do not insert or allow foreign objects to enter any ventilation or exhaust opening as this may cause an electric shock or fire, or damage the heater.
- To prevent a possible fire, do not block air intakes or exhaust in any manner (such as newspapers, table-cloths, curtains, etc.). Do not use on soft surfaces, like a bed, where openings may become blocked.
- **No naked flame sources, such as lighted candles, should be placed on the apparatus.**
- A heater has hot and arcing or sparking parts inside. Do not use it in areas where gasoline, paint, or flammable liquids are used or stored.
- Use this heater only as described in this manual. Any other use not recommended by the manufacturer may cause fire, electric shock, or injury to persons.
- Always plug heaters directly into a **MAINS socket outlet with a protective earthing connection**. Never use with an extension cord or relocatable power tap (outlet/power strip).
- Check if the voltage indicated on the nameplate of the appliance corresponds to the local mains voltage before you connect the appliance.
- **The appliance is not located immediately below a wall socket-outlet.**

- The casing and the front cover of the appliance become extremely hot during operation. Pay attention that, no combustible material due to wind or other environmental influences covers or obstructs the appliance, such as curtains, marquees, flags, plastic foil etc. Do not touch the appliance. Caution! Risk of scald injury!
- In case of improper use, there is a risk of electrical shock and/or fire hazard. Operation of the appliance must be discontinued and remove the mains plug immediately. Do not try to repair the appliance by your-self. Please contact with the service agent or a suitably qualified electrician for maintenance.
- Remove the plug from the power outlet and wait until the appliance is sufficiently cooled off before cleaning.
- The appliance must only be mounted by an authorized specialist, paying attention to the relevant regulations of the power supply companies and the regional construction regulations.



- Note: This product is strictly prohibited to cover.

Save These Instructions

Specifications

Specification	<input type="checkbox"/> LDHR016-250KB
---------------	--

Voltage (V)	<input type="checkbox"/> 220-240V~ 50/60Hz
Power consumption (W)	<input type="checkbox"/> 2500W
IP code	<input type="checkbox"/> IP65
Remote control mode	<input type="checkbox"/> BLE、433Mhz Wireless
Bluetooth receiver distance	<input type="checkbox"/> $\leq 20M$
Action angle of tilt switch	<input type="checkbox"/> $50^{\circ} \pm 10^{\circ}$ (360°)





BLUETOOTH OPERATION

The 'Sunkare Heater' App will allow you to connect remotely to many heaters and control them independently. Control functions include:

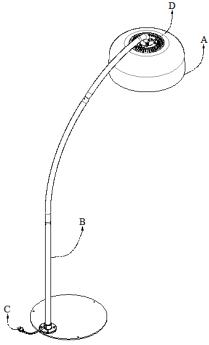
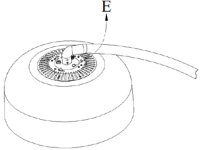
- On/Off
- Variable heat output from 0 to 100%
- Timer with auto shut off
- Password connection to heaters
- Individual heater identification and control
- To download, search for 'Sunkare 'in your App store and add to your device.

Function Instruction

	Remark	Name	Function
	A	Heating module	Heating
	B	Heater stand	Fixed heating module
	C	Plug	Connecting the power
	D	Switch	On/off
	E	Reset button	<p>1、 Turn on position, Press the reset button more than 5 seconds. then the Bluetooth password will be resetted.</p> <p>2、 Standby position, Press the reset button more than 5 seconds. then press any buttons on remote control, heater and remote control will be matching.</p>

	Button	Graphic	Feature
	Up Arrow		Up one heating level
	Max		The heater goes directly to the highest heating level.
	Down Arrow		Down one heating level
	On		To switch the heater on: Press ON. The patio heater has a soft start function of 33% power. 4 seconds after the heater has been turned on, it will automatically switch to the last heating level used. In case of the first-time use, after 4seconds

			the heater will automatically switch to 100% power.
	Off		To switch the heater off: Press OFF. The heater will switch to standby mode(the receiver indicator will light up).

Notice:

- Use 2 pieces AAA size 1.5V batteries in the remote control. Remove the battery when not use for long time, thus the lifespan of remote control can be extended.
- Choose the same specification battery when replacing the battery inside, otherwise it may cause remote control not work , thereby affect the normal use of the heater.
- Please contact service agent for further help if you need the function.
- The remote control function may be out of work if there is a barrier between the remote control and heater .
- Replacing the batteries duly so as not to affect the normal use of heater and remote control.

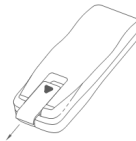

Operation Instruction

- Install the heater according to the following steps.
 - 1,Open the outer carton,remove all the packing materials(including heating lamp shaking protection packing),then check if everything is OK for the heating mould,heater stand mould,wire cable and plug.
 - 2,Take out of the heating mould,heater stand mould,heater stand base,screws and assembling tools.
 - 3,Connect the two curved poles.see Fig.1.then put 3pcs M6X8 in the corresponding holes,tight them by tools.Please pay attention that Do not damage the wire cable during the

assembling.

4, Connect the curved pole to the straight pole. see Fig.2 then put 3pcs M6X8 in the corresponding holes, tight them by tools. Please pay attention that Do not damage the wire cable during the assembling.

5, Connect the whole poles to the round base with 4pcs M8x8 screws. See Fig.3

6, Connect the round based to the ground by expansion screws. see Fig.4

7, Connect the heating mould to the heater stand mould by M8X50 and 2pcs M8X10 screws. Connect the easy fitting plug devices between the heating mould and heater stand mould. and tight them. see Fig.5

8, Turn on the switch and connect the power, to check if the heater can work well.

9, Don't move, cover or climb the heater while it is working. See Fig.6

- Pay attention to the mounting place and all mounting material(dowels, screws). Ensure they are suitable and stable enough for mounting and lastingly holding of the appliance.
- Pay attention that, the installation of the appliance must not add excessive wind load.
- Adjust the desired angle of radiation and fest screw all screws. Check regularly the screw's connection. Mechanical bearing pressure and oscillation due to wind or rain could lead to loose.

- Plug in the power source and operate the remote control. Then observe, whether during the first 10-15 minutes the appliance works trouble-free.
- If you do not use, please remove battery socket.

Figure1

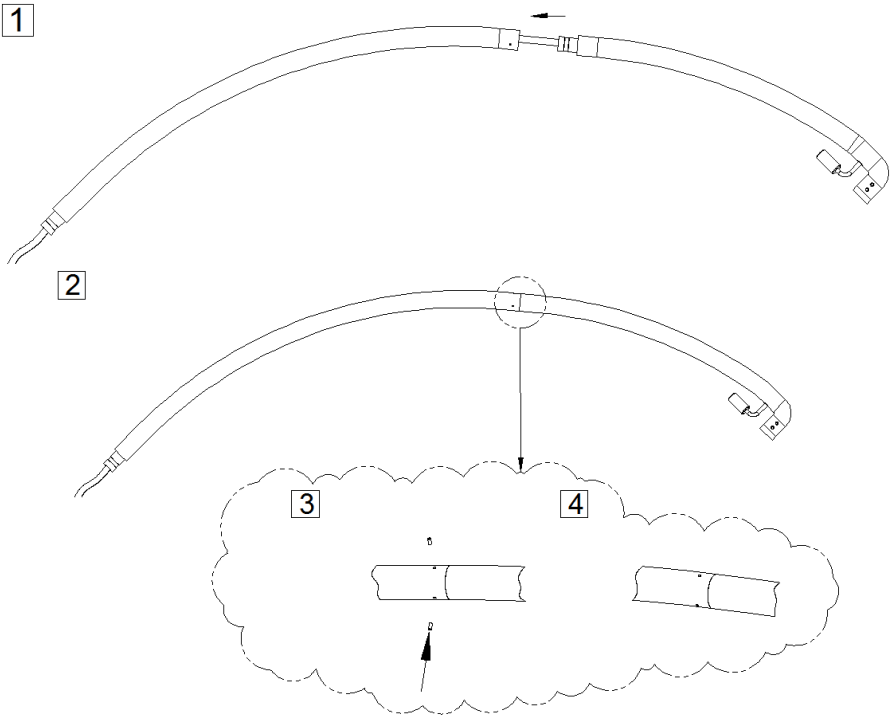

Figure2

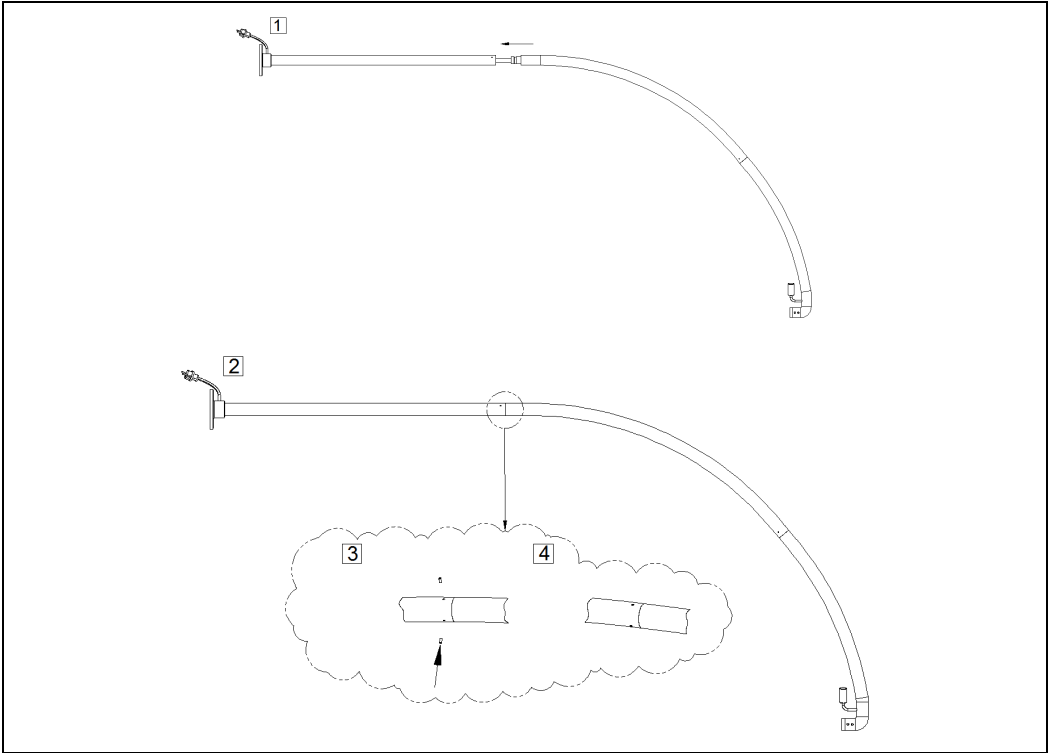

Figure3

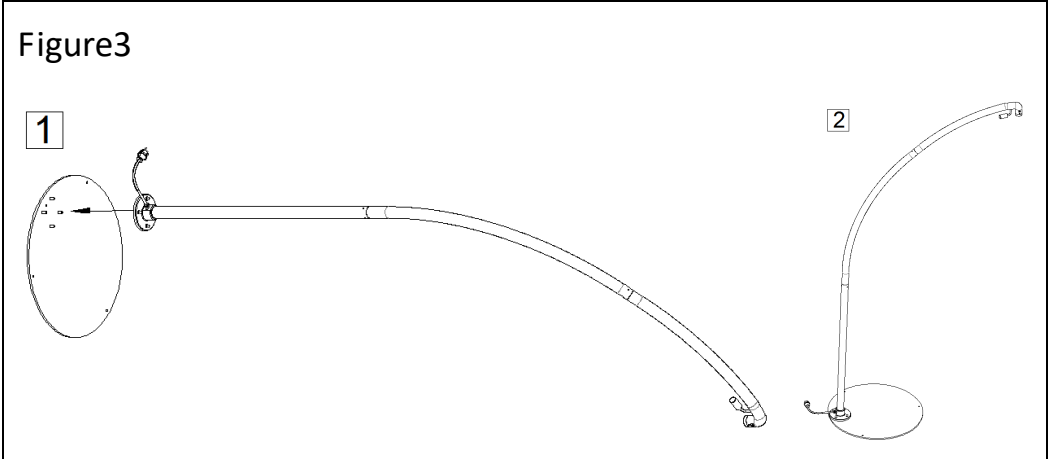

Figure4

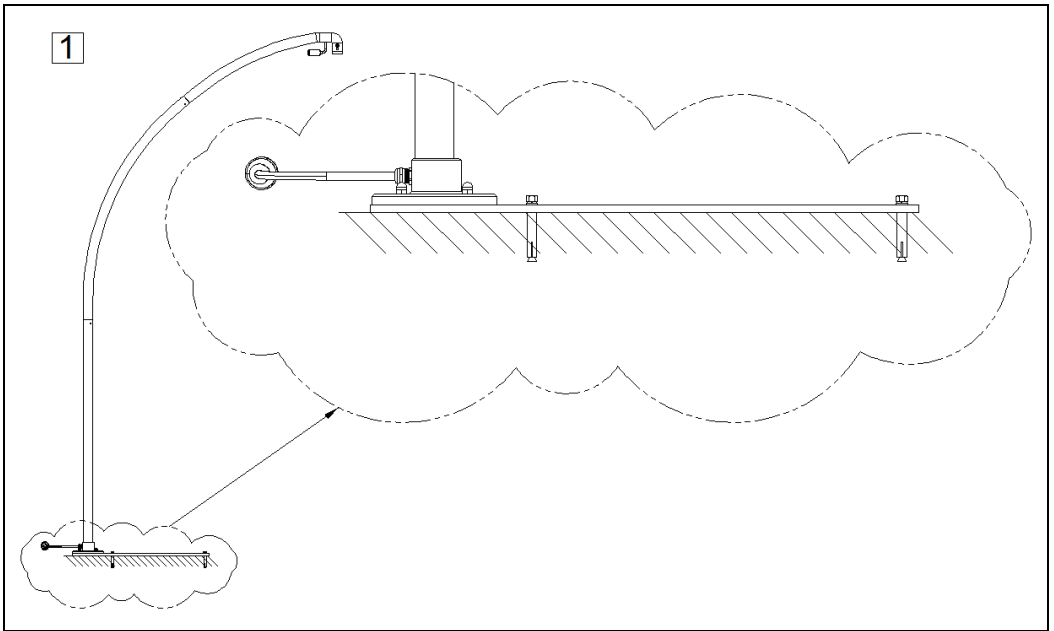

Figure5

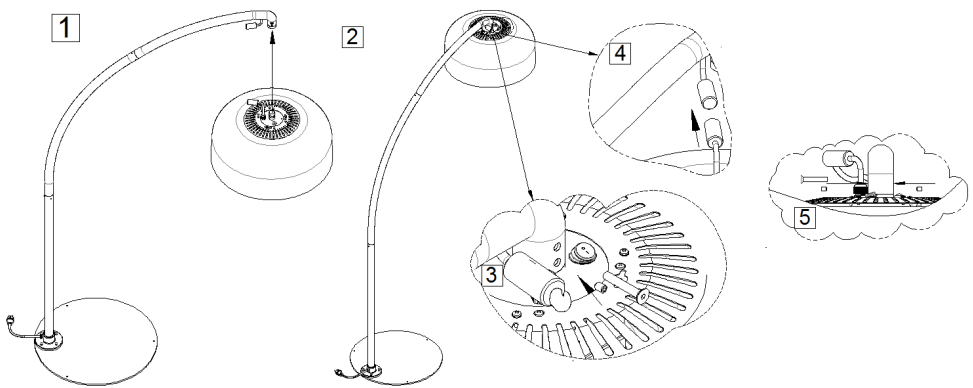
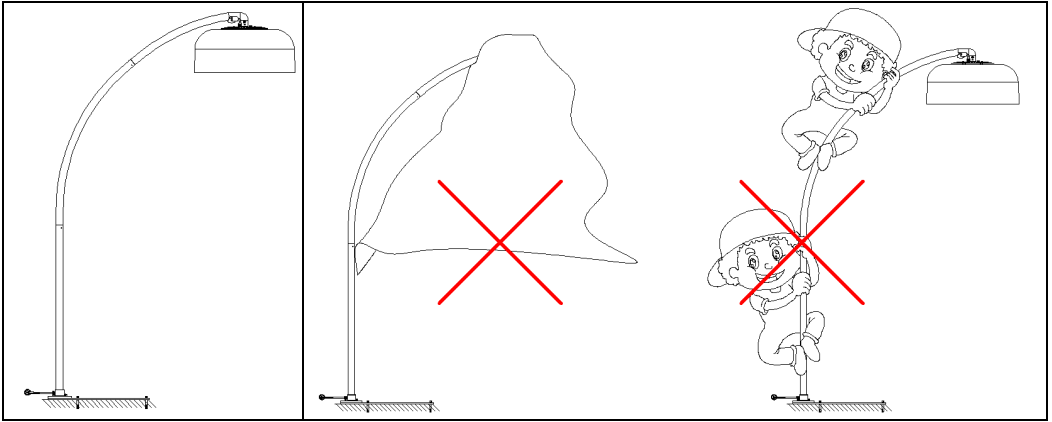

Figure6



Cleaning and Maintenance

- This appliance is consist of a robust and maintenance-free aluminum casing with a protection cover. No user serviceable parts inside.
- Before cleaning,remove the plug from the power outlet and wait until the appliance is sufficiently cooled off.
- Wipe the appliance only with clean and lint-free cloth or a soft brush.
- Never use abrasive cleaners, scrubbing brushes and chemical cleaners for cleaning!
- Can use alcohol to clean the appliance.
- To protect against electrical shock and danger of life, do not immerse cord, plug, or any part of the appliance in water or other liquid.
- For heating element replacement, please contact the manufacturer or its service agent or a similarly qualified person.
- Any other service, please contact with the service agent or

a suitably qualified electrician.

Storage

Do not route cord when heater storage, or heater is not in use.

Disposal



This marking indicates that this product should not be disposed with other household wastes throughout the EU. To prevent possible harm to the environment or human health from uncontrolled waste disposal, recycle it responsibly to promote the sustainable reuse of material resources. To return your used device, please use the return and collection systems or contact the retailer where the product was purchased. They can take this product for environmental safe recycling.

Customer Service

- Repairs must be carried out by authorized specialists, thus ensuring electrical safety.
- Please contact with the service agent or a suitably qualified electrician.
- Improper repairs could lead to danger to the user.
- This warranty does not cover damage of failure which results from alteration, accident, misuse, abuse, neglect, commercial use or improper maintenance.
- In line with our policy of continuous product development we reserve the right to change the product and

documentation specifications without notice.