

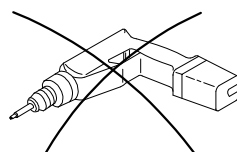

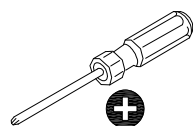

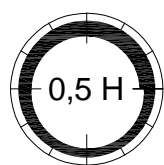

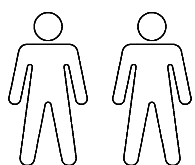
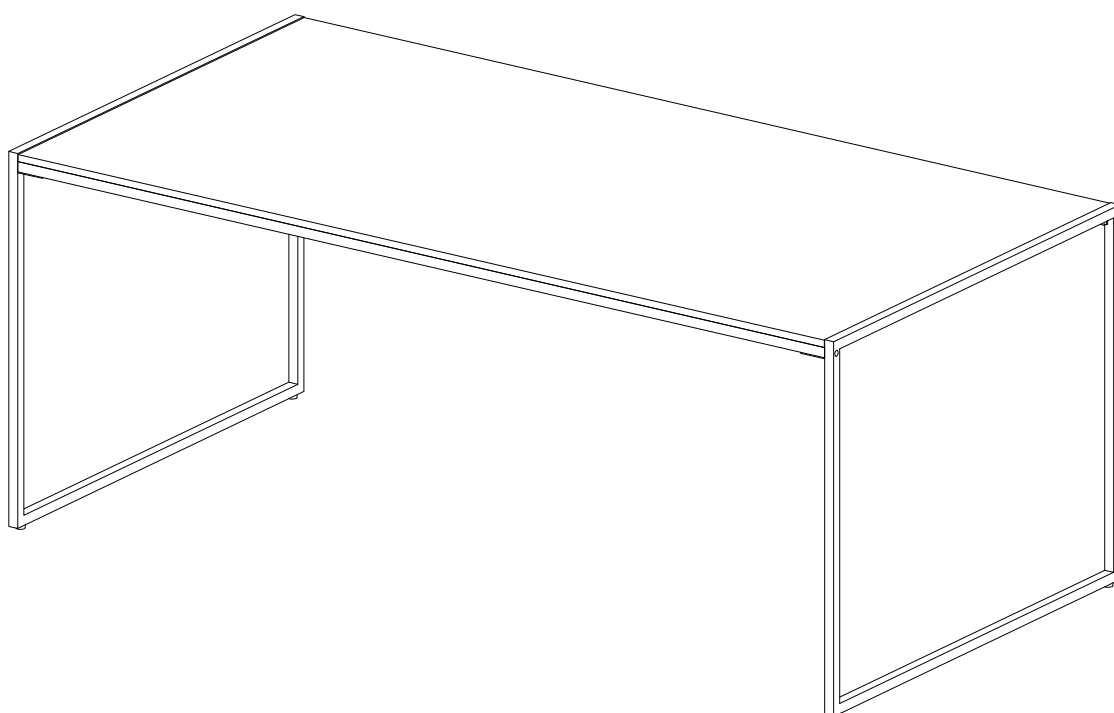
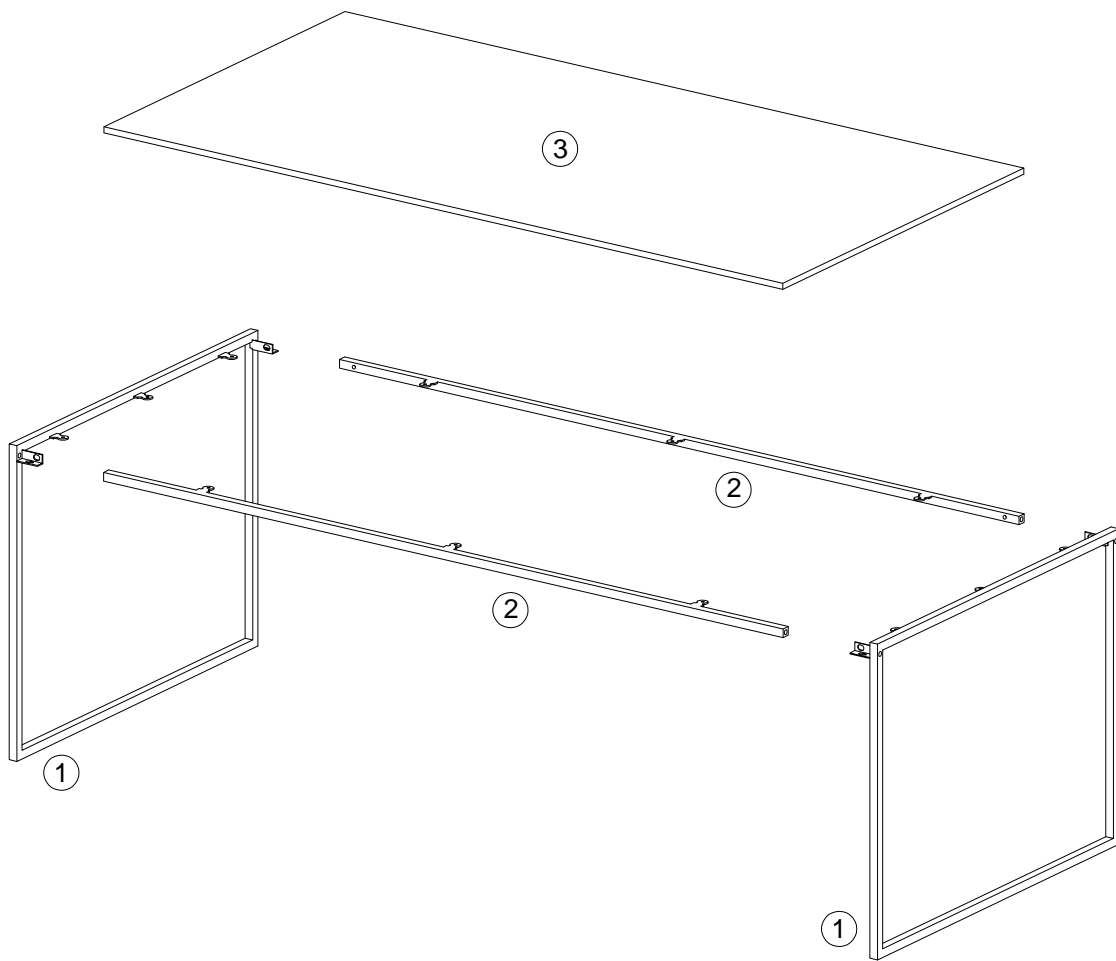

# Infinity





			✓
①	2	600x475x48/13	
②	2	1174x13x39/13	
③	1	1173x600x9	





<p>A x 4</p>  <p>M5x28 mm</p>	<p>B x 8</p>  <p>M6x10 mm</p>	<p>C x 12</p>  <p>Ø4x10 mm</p>	<p>D x 4</p>  <p>M6/Ø13 mm</p>	<p>E x 1</p>  <p>4 mm</p>
<p>F x 1</p>  <p>3 mm</p>	<p>G x 12</p>  <p>Ø4/Ø9 mm</p>			

# 1

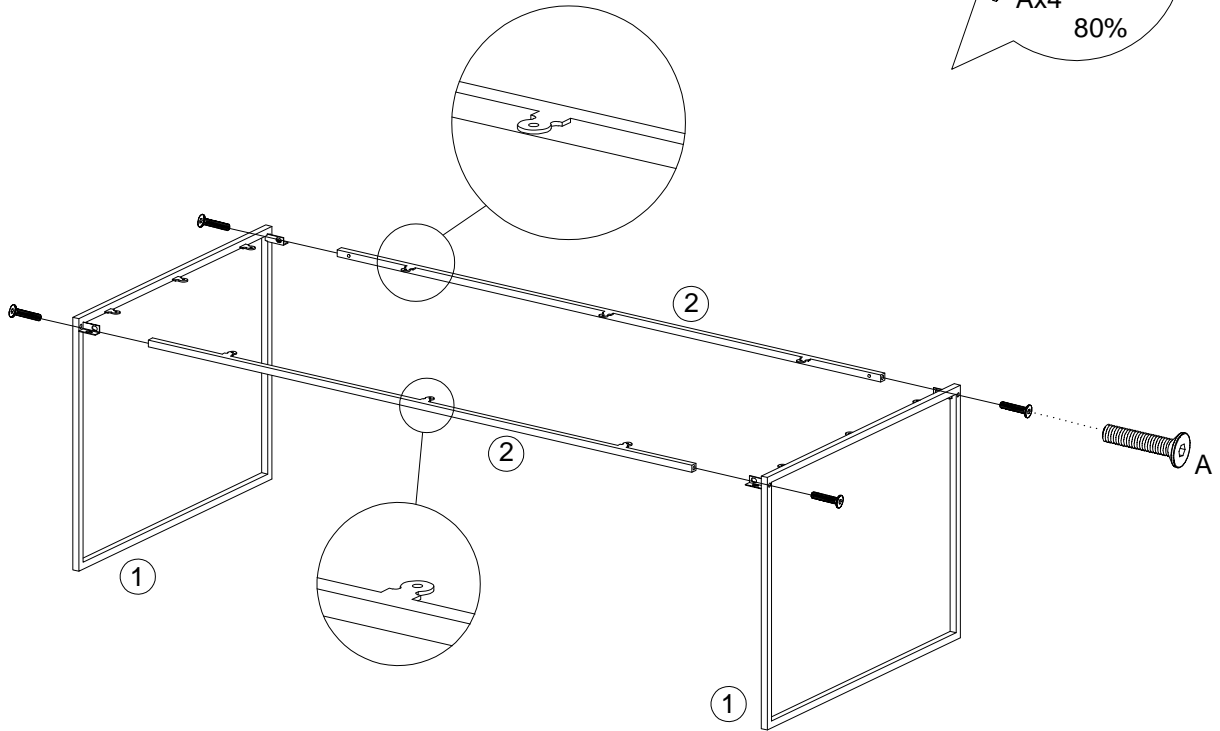
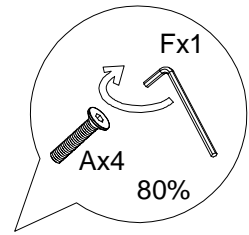
A x 4  M5x28 mm	F x 1  3 mm
--	--



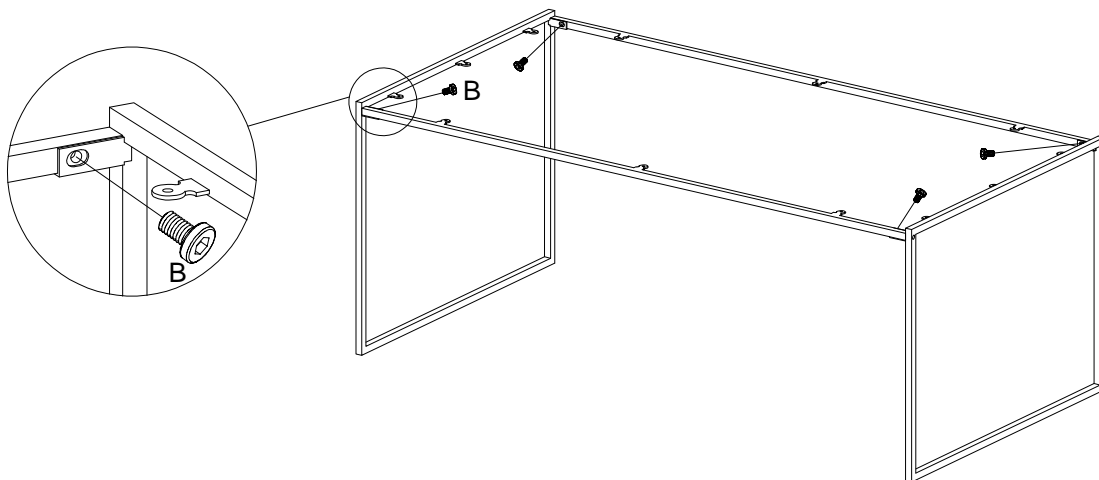
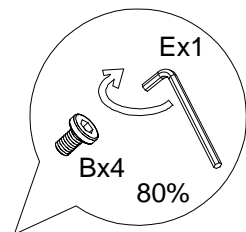

# 2

B x 4  M6x10 mm	E x 1  4 mm
--	--





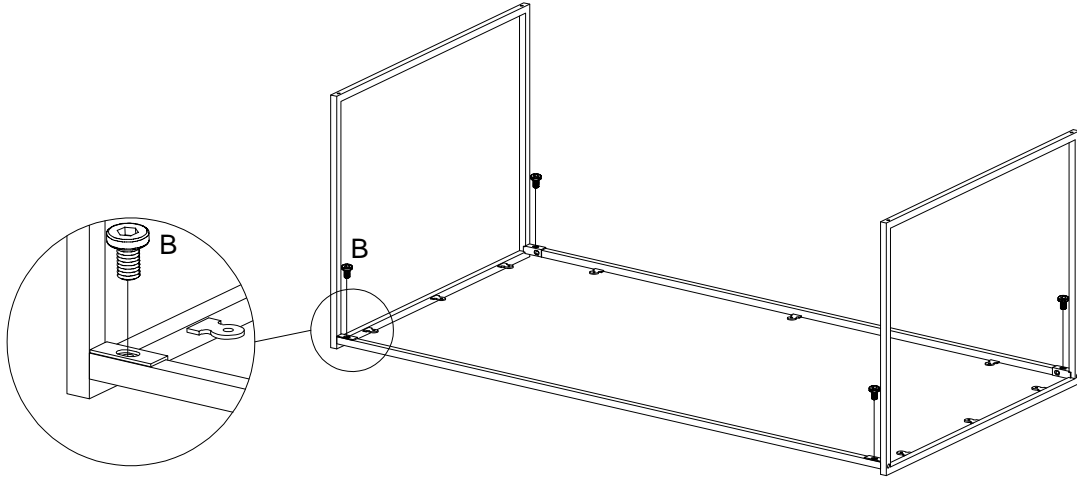
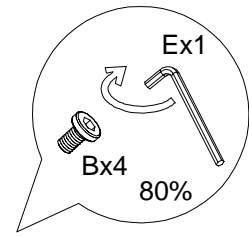

# 3

B x 4  M6x10 mm	E x 1  4 mm
--	--



# 4

C x 12  Ø4x10 mm	D x 4  M6/Ø13 mm	E x 1  4 mm	F x 1  3 mm	G x 12  Ø4/Ø9 mm
---	---	--	--	---

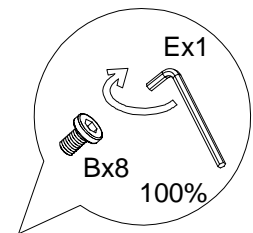
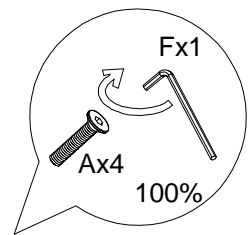
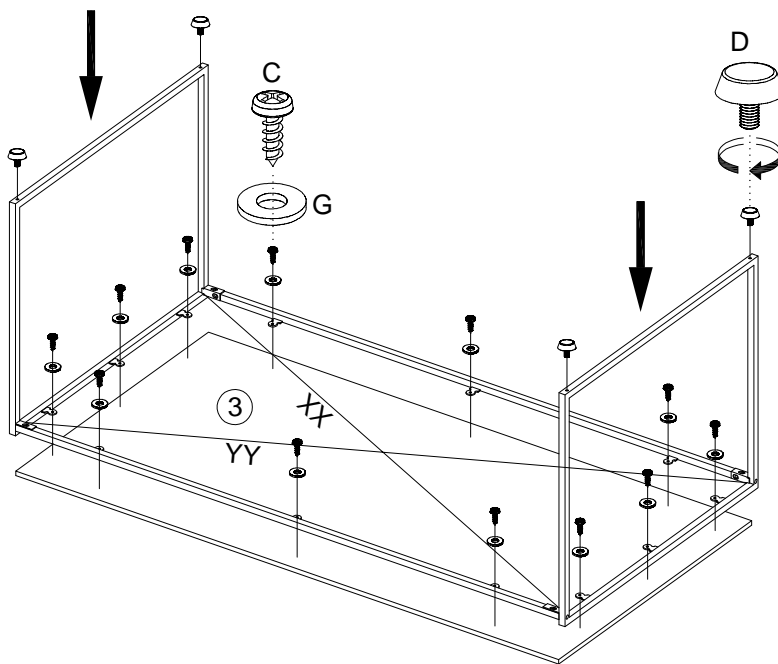
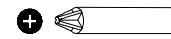

5

