

ASSEMBLY INSTRUCTION

HAMMOND COFFEE TABLE 135X62 MARBLE TOP

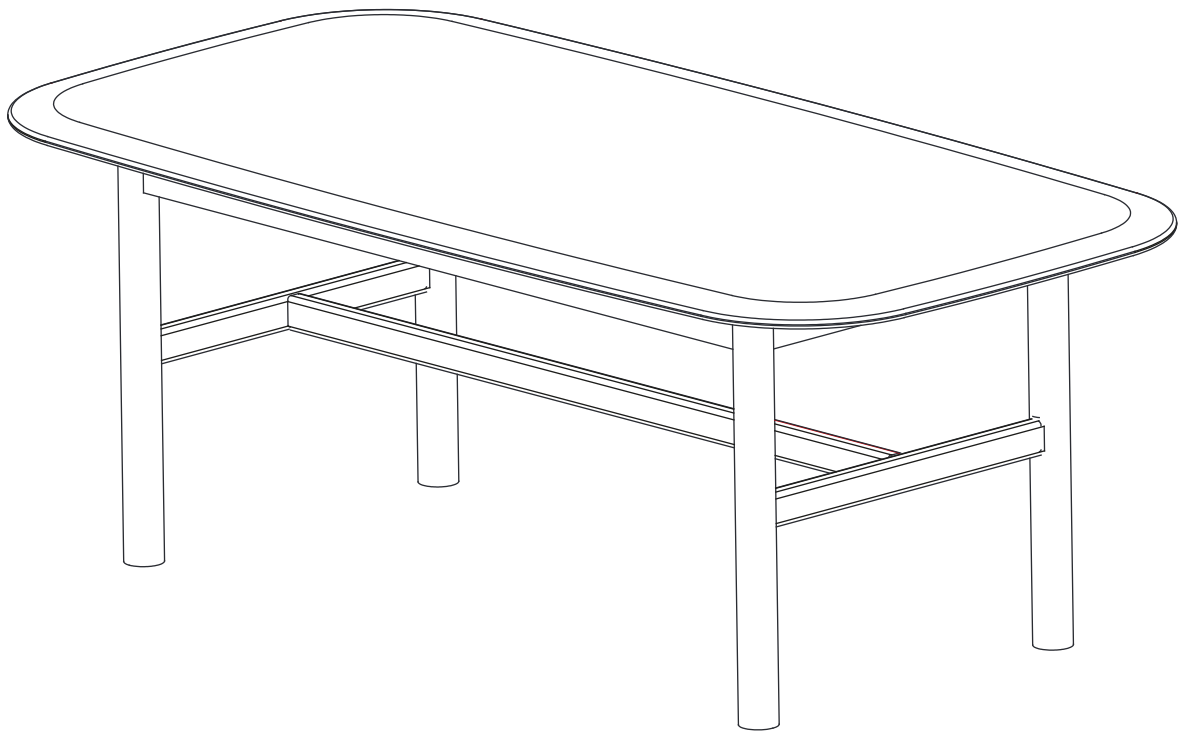

ROWICO

H O M E

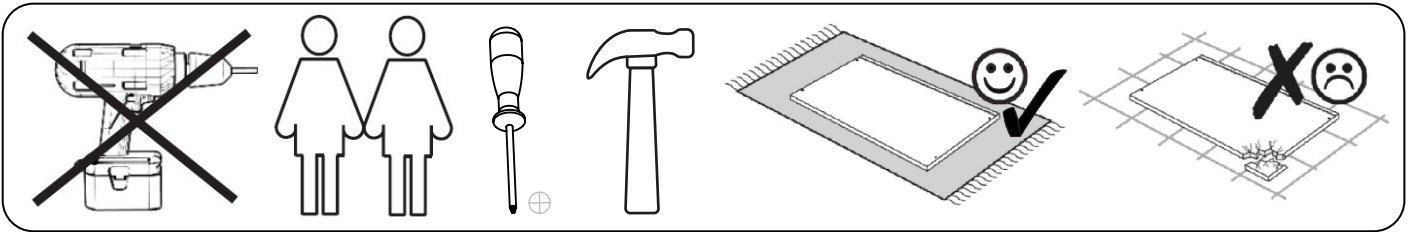

Ax2 	Gx2
Bx1 	Hx2
Cx2 	Jx2
Dx1 	Kx1
E x8 	Lx4
Fx4 	Mx4
	Px4

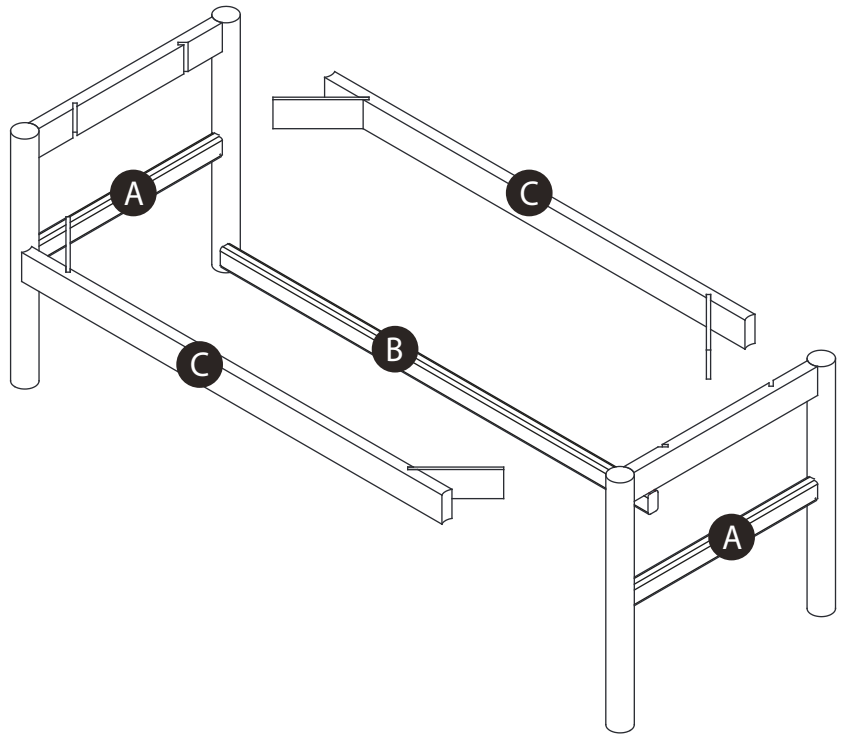

①

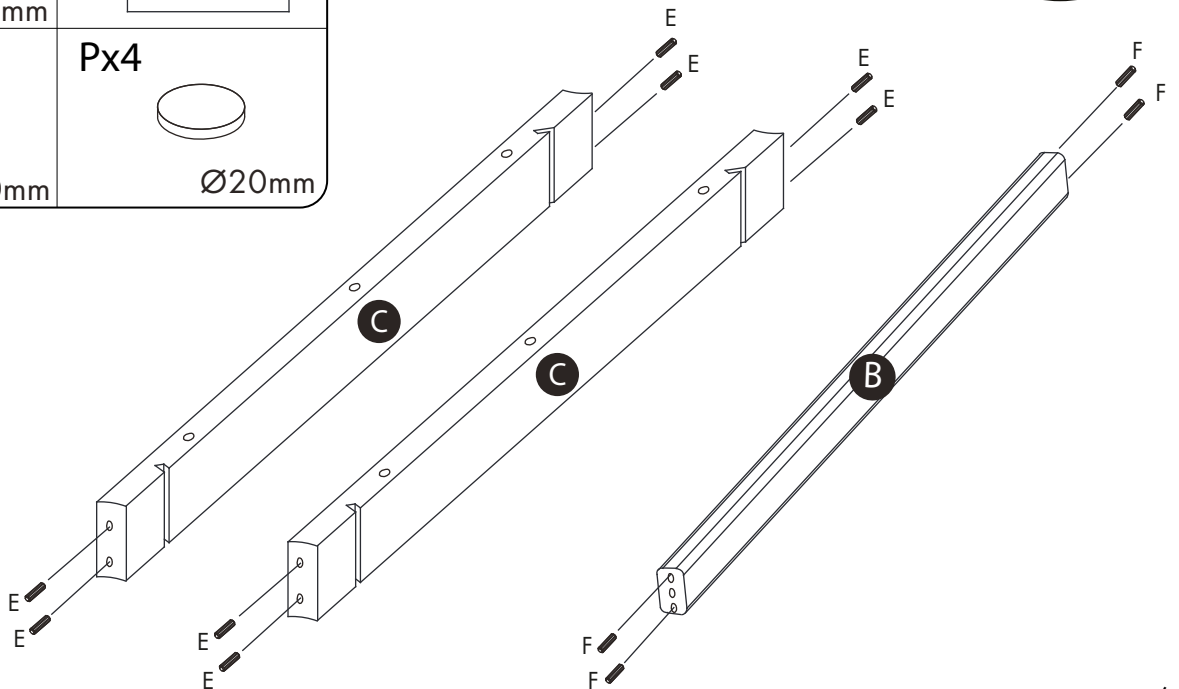
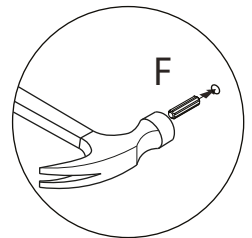
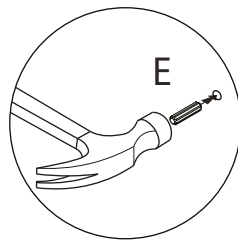

②

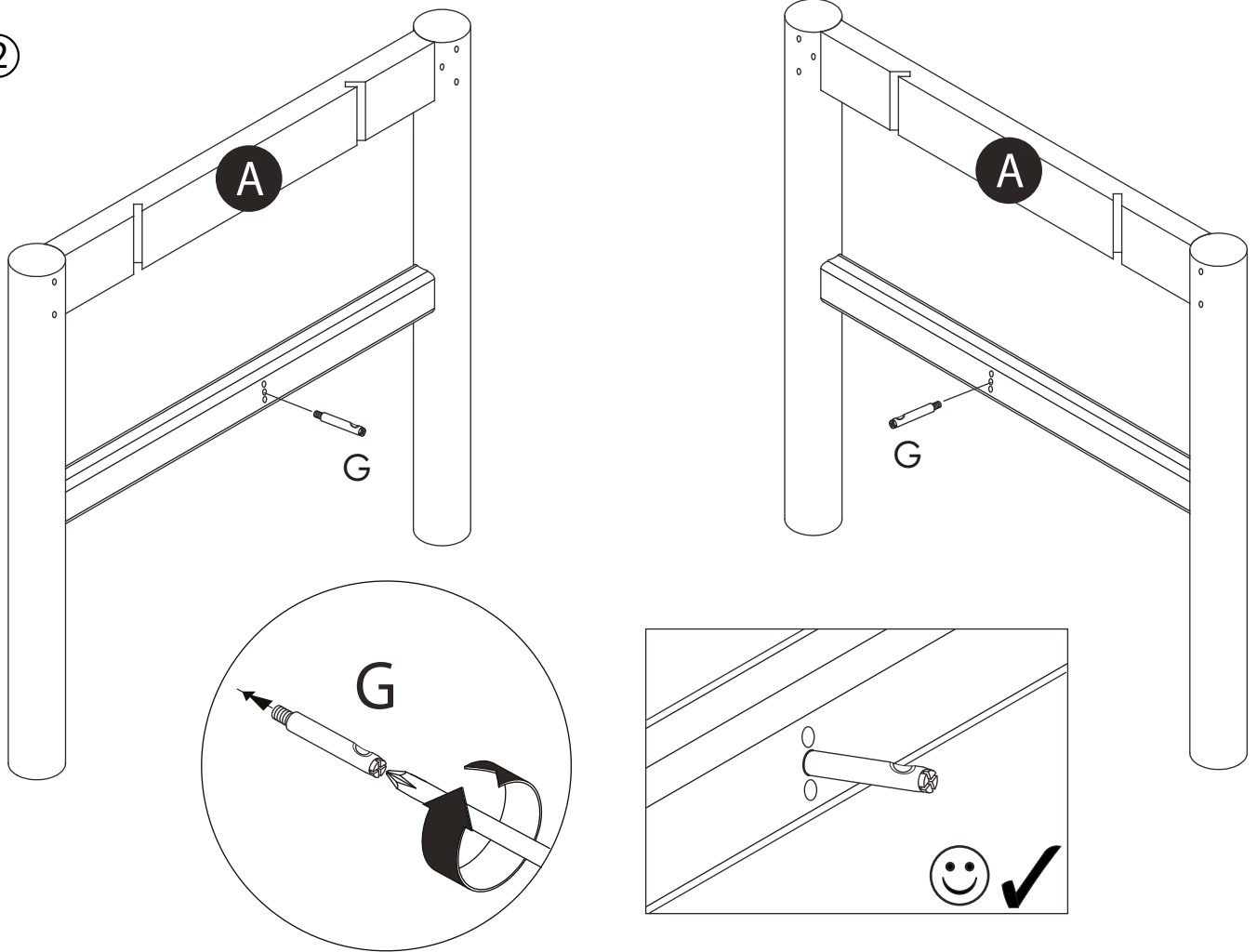

③

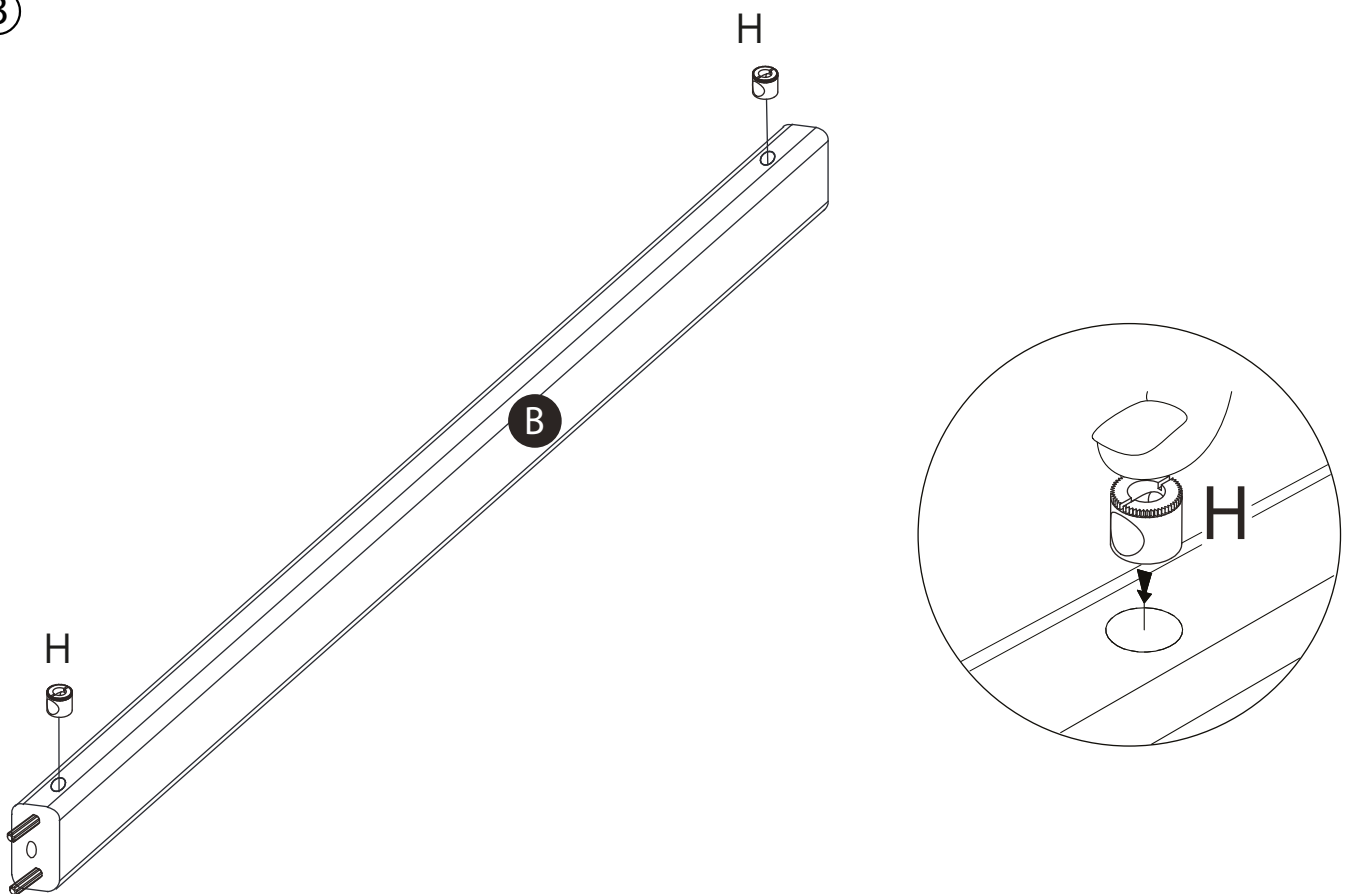

④

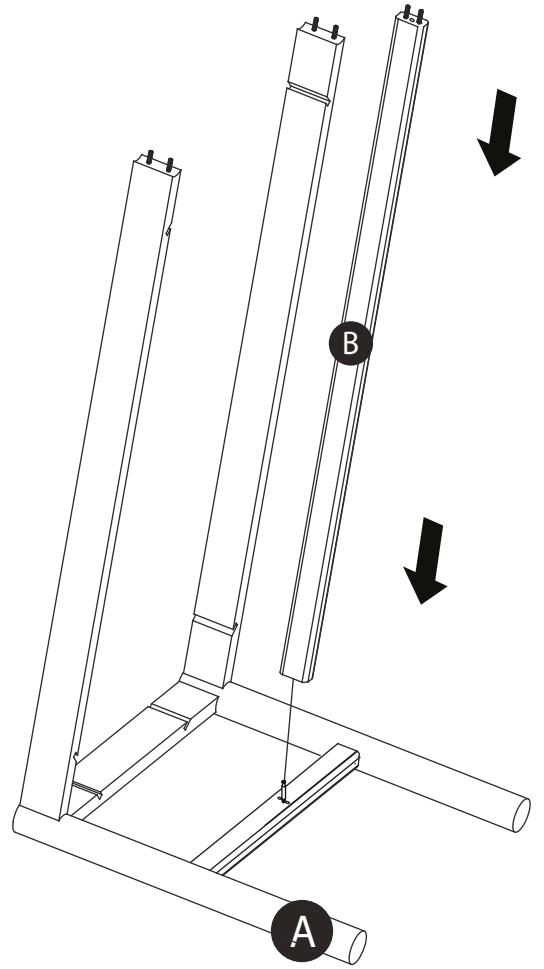
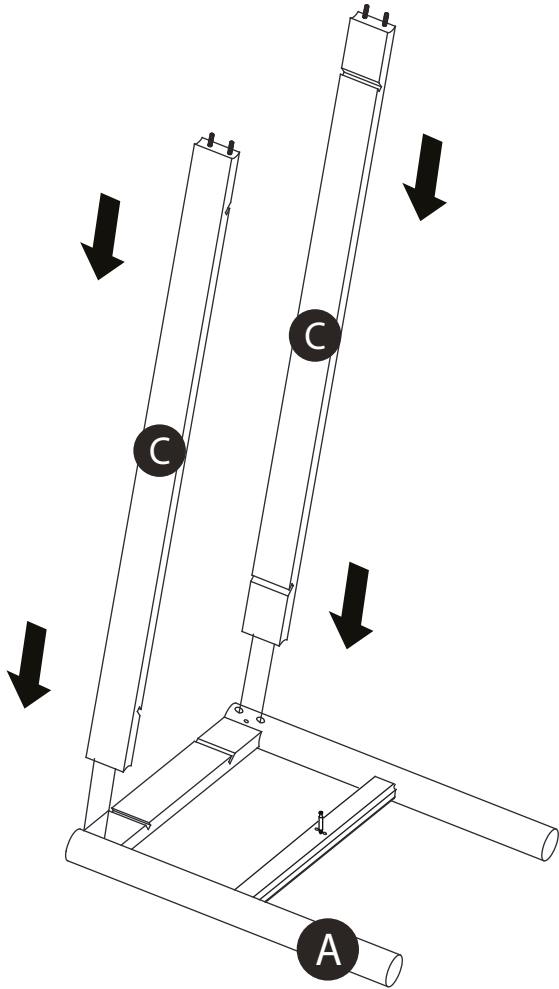

⑤

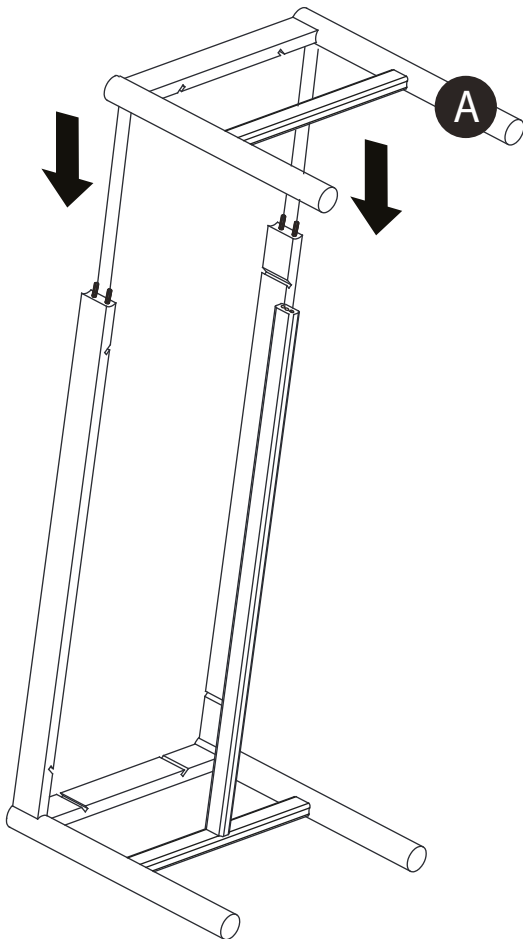

⑥

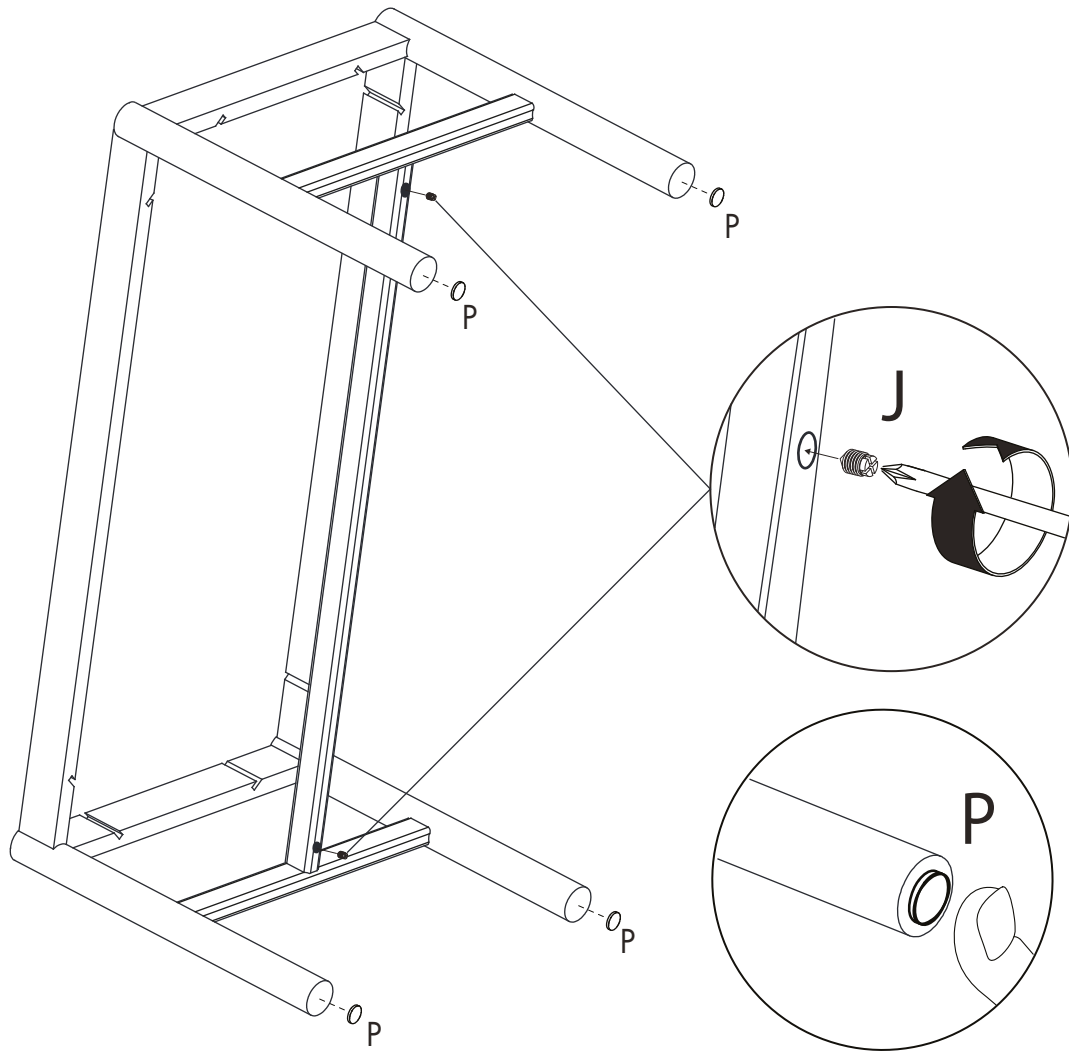

⑦

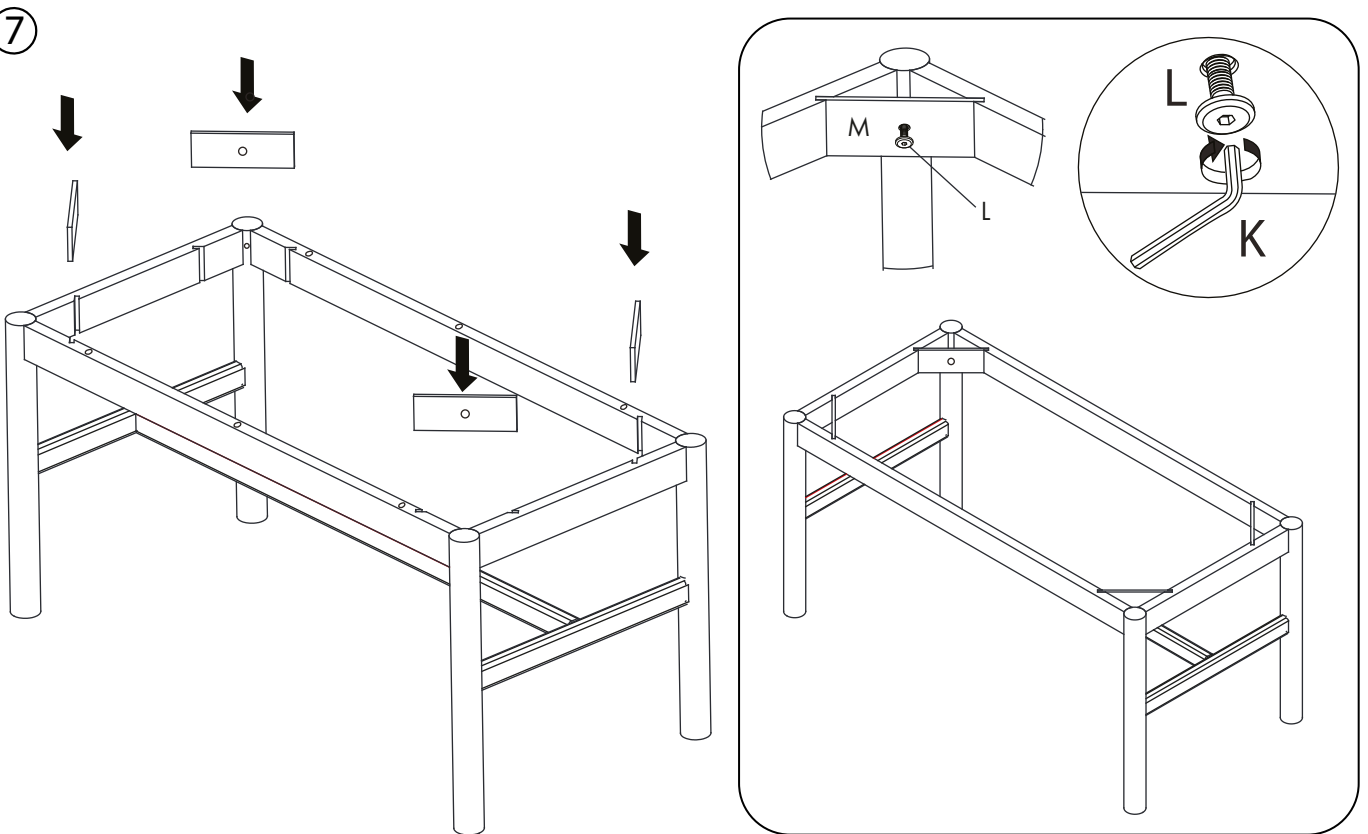

8

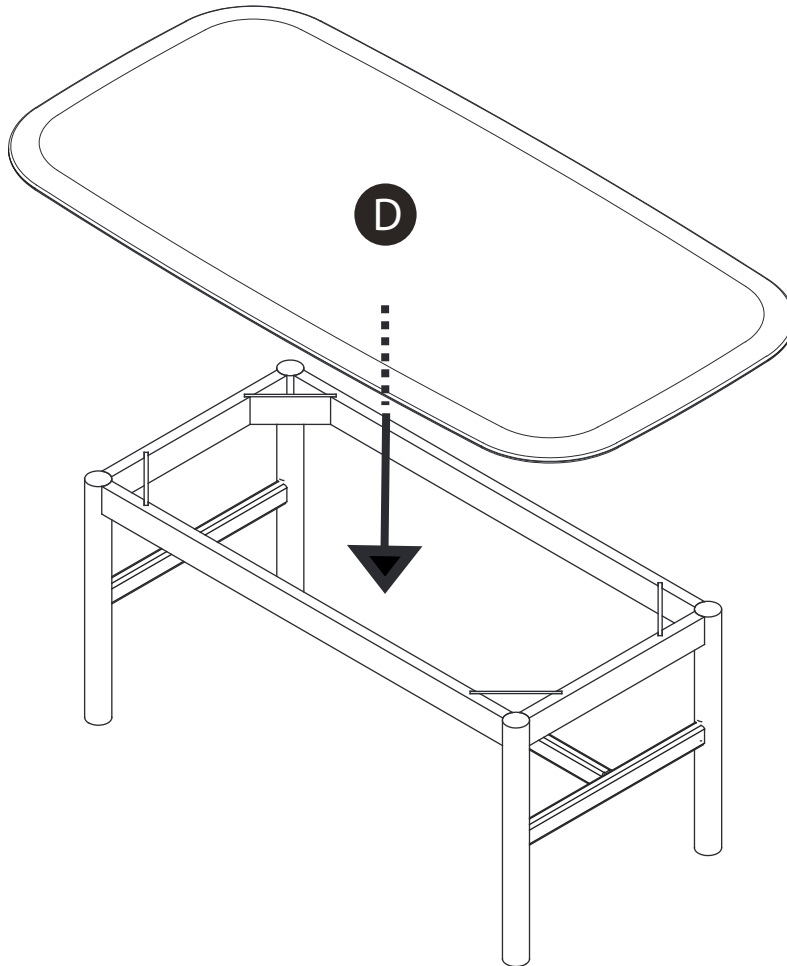

Hantera marmortoppen med stor försiktighet.

Var noggrann med att alla fyra MDF-klossar på undersidan av marmortoppen kommer innanför benstativets ram.

Handle marble top with great care. Make sure that all four MDF blocks on bottom side of the marble top are located inside the frame of the wooden leg base.

