

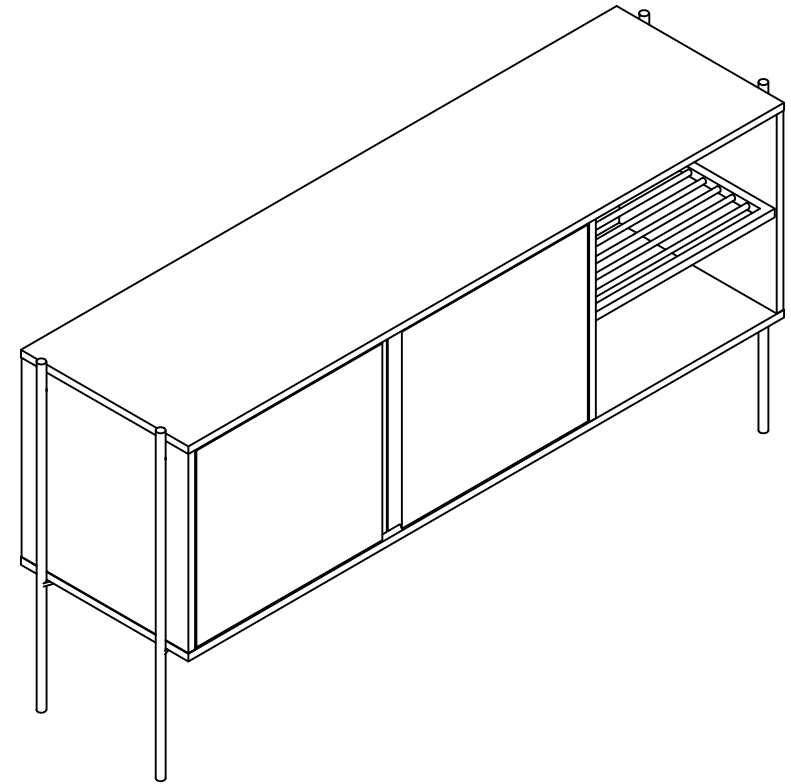

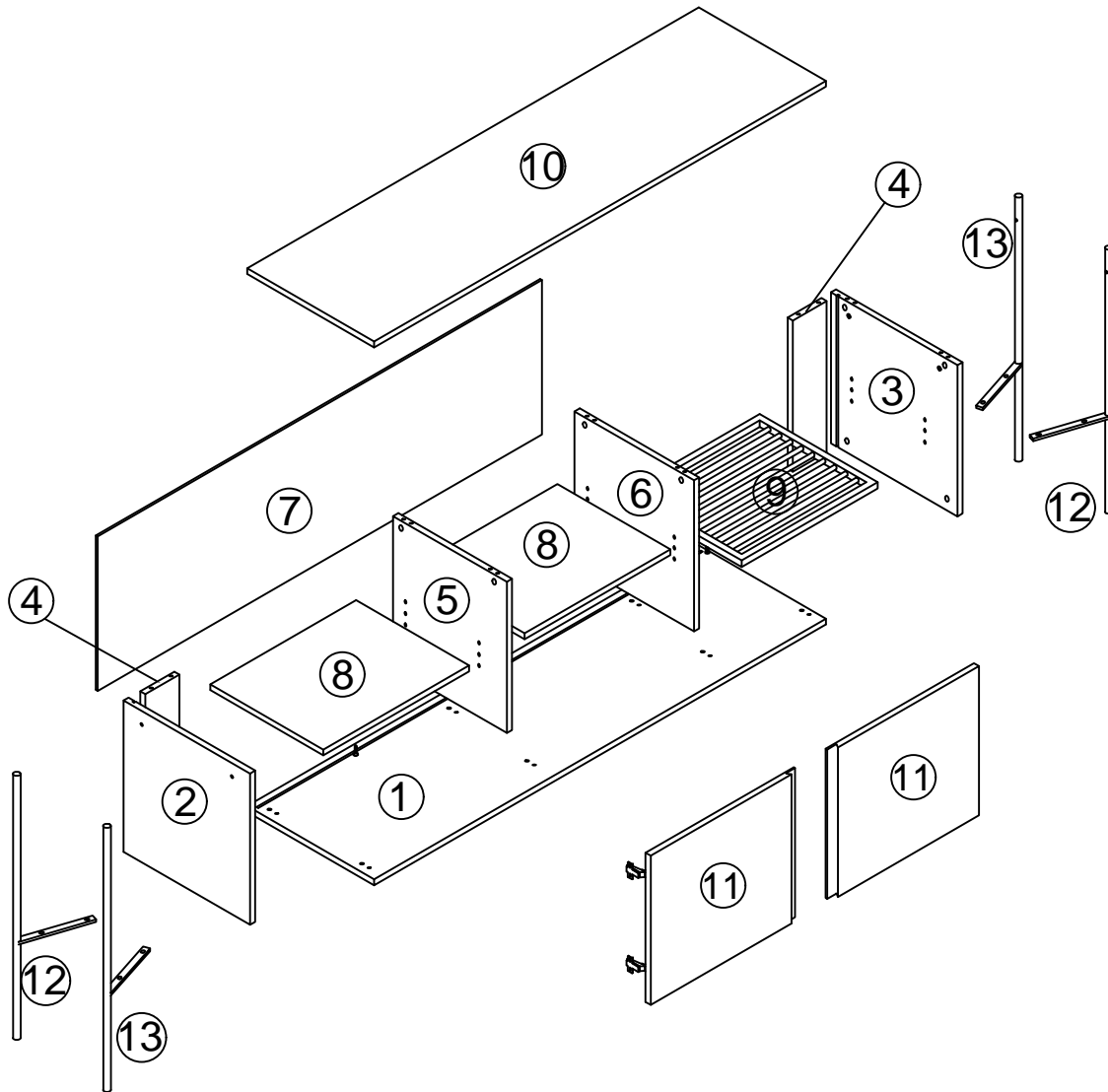













# J9857



A	 $15 \times 12$	x28	H	 #4	x1	O	 20	x28
B	 M6*32	x28	I	 #4	x4			
C	 8*30	x16	J	 10*12*5	x6			
D	 M6*20.5	x12	K	 M3*16	x6			
E	 M3.5*14	x28	L	 Ø8*40	x4			
F	 M6*25	x4	M	 M4*35	x4			
G	 M6*20	x8	N	 L=350	x2			

**01**

Bx24

1 5 6 10

B		x24
C		x8

**02**

2 3 4

Ax2

B		x4
A		x12

**03**

1 3 5 6 8 10

A		x16
C		x8
D		x12

**04**

1 3 5 6 8 11

Ax2

Kx6

Jx6

Ox28

Ex24

J		x6
C		x6
D		x4
E		x24
K		x6

