







1714117-01-0

Rue Side Cabinet

A	B	C	D	E	F
					
M8*15 x8	M6*10 x4	M6*55 x4	M6*Ø16*2 x4	5# x1	4# x1

03

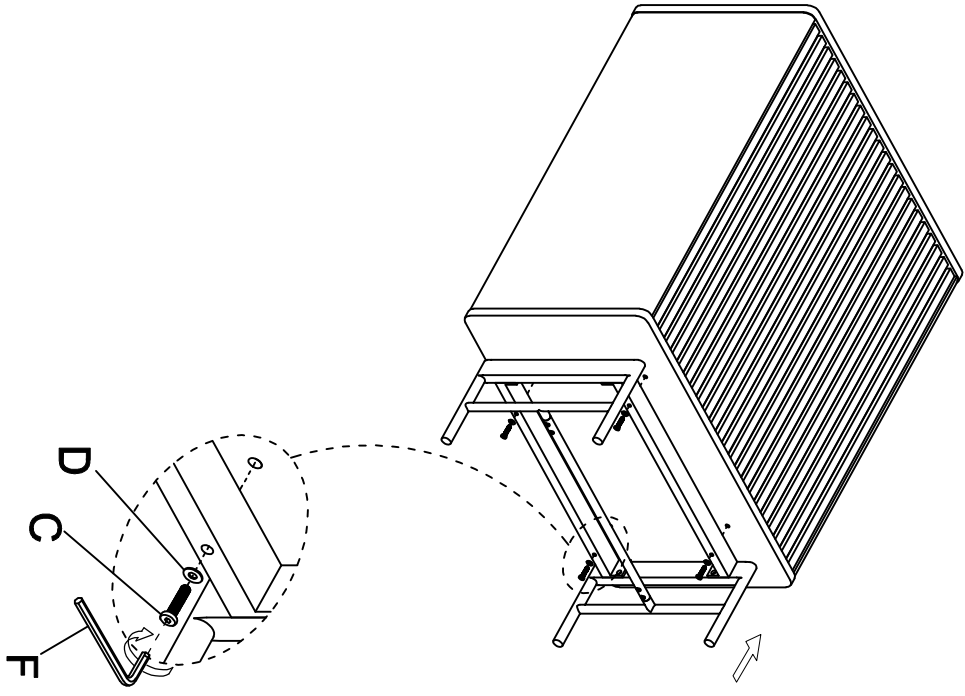

04

