

MINT

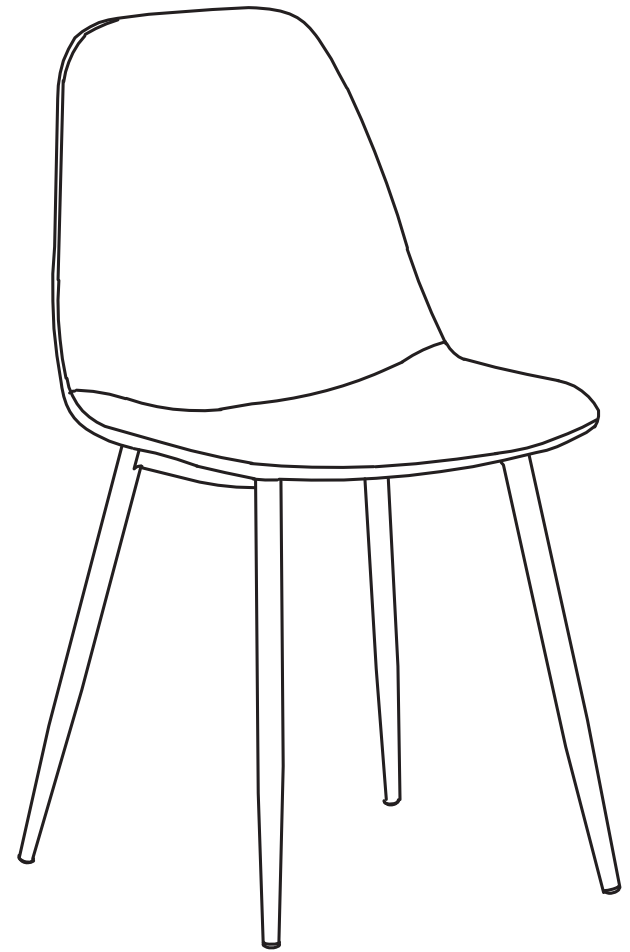

1

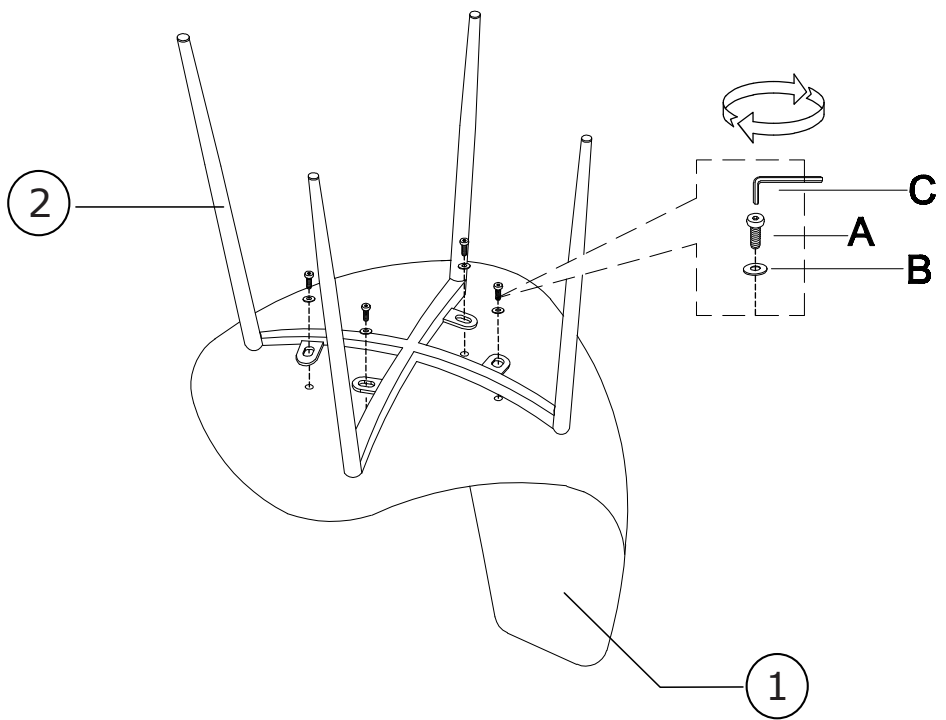

Bx4



Ax4



Cx1

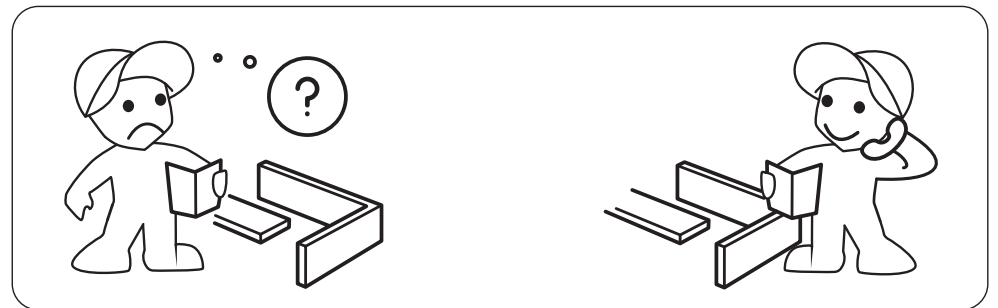
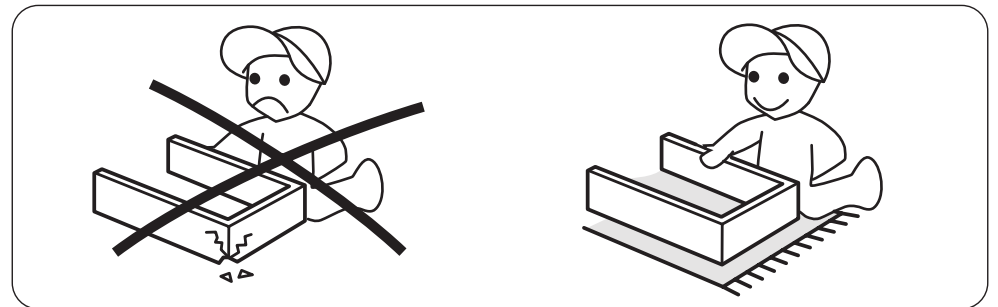
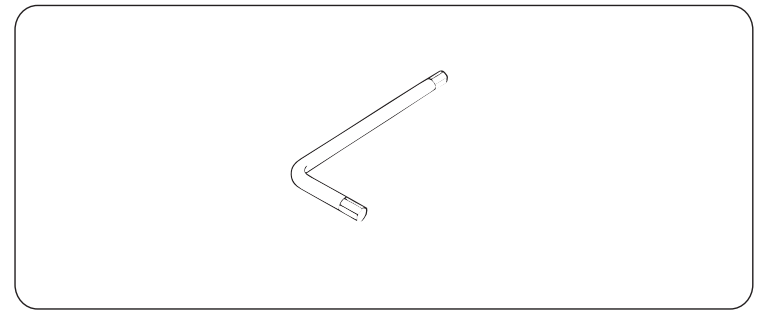

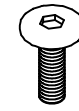
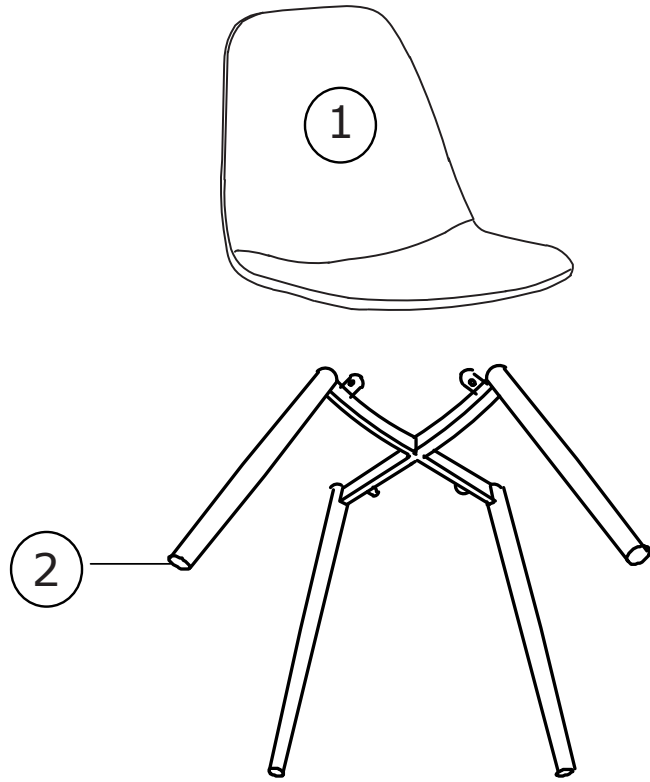

Ax4
16mm



Bx4
M6xΦ16mm



Cx1
M5