

# Assembly Instruction

MONTERINGSANVISNING \* MONTAGEANLEITUNGEN

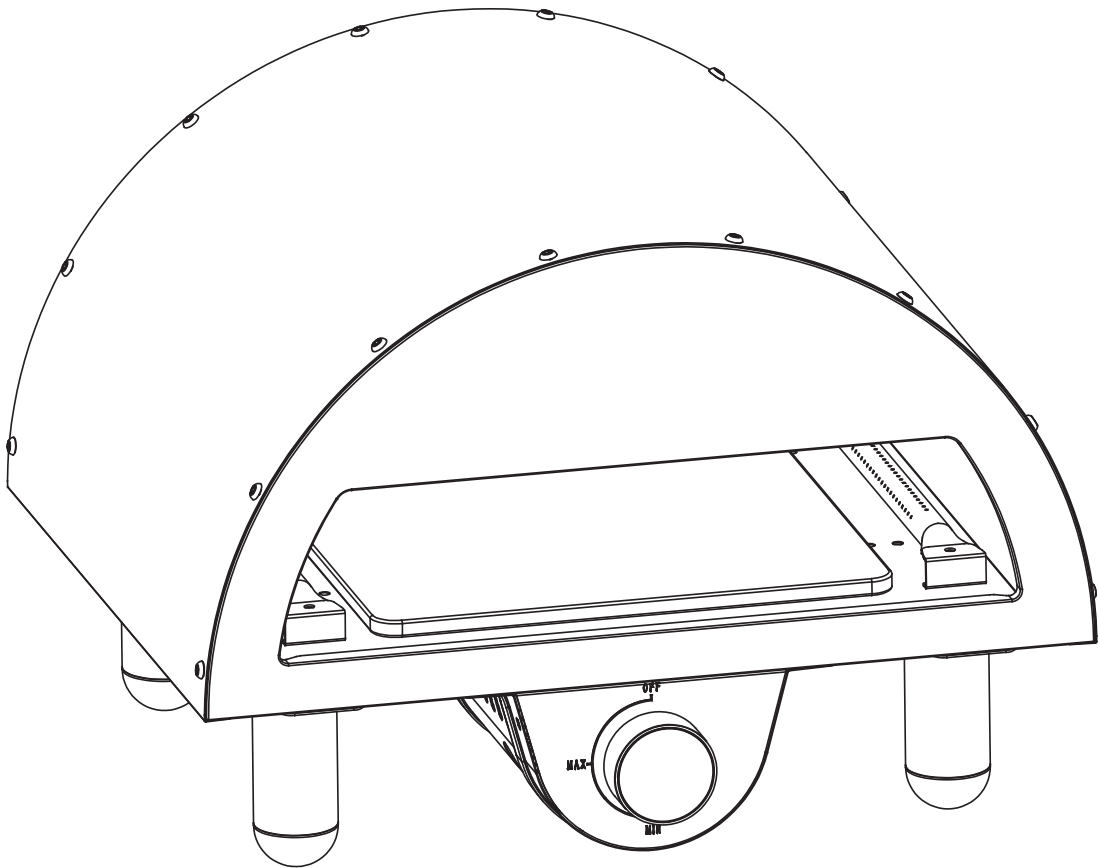

ProductNumber: 6083-001

Description: Sentosa Pizzaoven



@Venturehomese  
@Venture.Design

Do not tighten screws until all screws  
have been assembled !

Venture  
home





Grattis till din nya utemöbel.

Det är viktigt att veta hur man ska ta hand om sin utemöbel på bästa sätt. Vi rekommenderar därför att ni surfar in på [www.venturehome.se](http://www.venturehome.se) och klickar vidare till "skötselråd" för att hitta utförlig information. På detta blad finner ni några generella tips och tricks.

**Stål:** Ha i åtanke att stål är ett material som kan rosta om det utsätts för vatten och fukt över en längre tid. Det är därför viktigt att hålla din möbel i stål torr, genom att till exempel använda möbelskydd. Rost från insidan av din möbel kan rinna ner och missfärga ytan den står på. Kom ihåg det om du placerar möbelen på ditt nya trädäck.

**Aluminium:** Aluminium är ett lättare material än stål vilket gör din möbel lätt och smidig. Aluminium skall inte rosta men kom ihåg att vissa delar i din möbel fortfarande kan vara gjorda av stål (exempelvis skruvar eller beslag). Materialet är inte lika starkt som stål och det är därför viktigt att inte belasta din möbel i aluminium för mycket genom att undvika att stapla tunga föremål.

**Konstrotting:** Detta material är en plast som är mycket tålig när det kommer till väder och vind och dessutom lätt att underhålla. Kom ihåg att plast är ett material som expanderar och drar ihop sig beroende på temperatur. I höga temperaturer kan rottingen därför sjunka ihop något men kommer dra ihop sig igen när det blir svalare. Behöver du tvätta av din konstrottingmöbel gör du detta enklast med vatten och såpa.

**Teak:** Våra teakmöbler produceras av odlad teak, dvs. teak som är odlad för ändamålet att bli till möbler eller annat. Detta är alltså inte teak som är skövlad från ömtålig regnskog. Självklart är den även FSC-certifierad. Vill du behålla finishen i teaken bör produkten slipas och oljas med teakolja för att behålla färgen. Om detta inte görs får teaken den karakteristiska grå färg som kan närmast liknas vid drivved. Vi rekommenderar alltid att trät oljas för en så lång hållbarhet som möjligt. Utan olja kan torskprickor bildas i träet. OBS! tänk på att det är viktigt att materialet är torrt vid oljning.

**Aintwood:** Materialet är tillverkat av plast och framtaget för att efterlikna trä, men har bättre egenskaper för vårt skandinaviska klimat. Plast är känsligt för högre temperaturer. Möbler i aintwood bör därför inte placeras i ett oventilerat, inglasat utrymme där temperaturen kan bli hög. Platser att undvika på sommaren är växthus och inglasade verandor. OBS! Det är viktigt att komma ihåg att solljus som reflekteras i glas skapar en brännande effekt. Lämna därför aldrig några glasföremål utan uppsikt på ytan, eftersom det kan skapa "brännhål" liksom bubblor i plasten. För att undvika detta, använd alltid glasunderlägg och ta bort glaset när de inte används.

**Polyester:** Detta material används i nästan alla våra dynor och parasoll och ska ej maskintvättas, utan handtvätt är rekommenderat. Då polyester kan blekas vid direkt solljus rekommenderar vi att alltid förvara dynorna/parasollen i en dynbox eller under möbelskydd när de inte används. Detta för att förlänga hållbarheten och undvika missfärgningar.

Vi hoppas du får många sköna sommarstunder i din nya möbel!

OBS!

*Please be careful when assembling, if screws are tightened too hard (or by screwdriver), damages in the table top may appear. Tighten the screws after some time of using the product.*



@Venturehomese  
@Venture.Design

Venture  
home





Herzlichen Glückwunsch zu Ihren neuen Gartenmöbeln!

Es ist wichtig zu wissen, wie Sie Ihre Möbel am besten pflegen. Wir empfehlen Ihnen, auf [www.venturdesign.se](http://www.venturdesign.se) nach „Pfleheinweise“ zu gehen, um detailliertere Informationen zu erhalten. Auf diesem Blatt finden Sie allgemeine Tipps und Tricks zu verschiedenen Materialien.

**Stahl:** Denken Sie daran, dass Stahl ein Material ist, das rosten kann, wenn es über längere Zeit Wasser und Feuchtigkeit ausgesetzt ist. Es ist wichtig, dass Sie versuchen, die Stahlmöbel trocken zu halten, indem Sie beispielsweise eine Möbelabdeckung verwenden. Rost von innen oder auf den Möbeln kann abtropfen und die Standfläche verfärben. Denken Sie daran, wenn Sie es auf Ihrer neuen Holzterrasse platzieren.

**Aluminium - Aluminium** ist ein leichteres Material als Stahl und macht Ihre Möbel leicht und flexibel, dieses Material sollte auch nicht rosten. Einige Teile Ihrer Möbel können jedoch weiterhin aus Stahl bestehen (z. B. Schrauben oder Beschläge).

**Künstliches Rattan (Weide):** Dieses Material ist unglaublich dankbar und erfordert wenig Pflege, um einen guten Zustand zu erhalten. Das Material ist UV-beständig und hält Wetter und Wind stand. Es ist wichtig zu bedenken, dass Korbwaren aus Kunststoff bestehen und sich daher entsprechend verhalten – sich je nach Temperatur ausdehnen und zusammenziehen. Wicker dehnt sich aus und lockert sich, wenn es warm ist, zieht sich dann aber wieder zusammen, wenn es kälter wird.

**Teak:** Unsere Teakholzmöbel werden aus kultiviertem Teakholz hergestellt, d. h. Teakholz, das zu dem Zweck angebaut wird, Möbel oder etwas anderes zu werden. Das bedeutet, dass unser Teakholz nicht zur Abholzung der tropischen Regenwälder beigetragen hat. Natürlich ist es auch FSC-zertifiziert. Um das Finish und die Farbe Ihres Teakholzes zu erhalten, sollte es mit Teaköl behandelt werden. Geschieht dies nicht, bekommt das Teak die charakteristische graue Farbe, die fast mit Treibholz zu vergleichen ist. Wir empfehlen Teak immer zu behandeln, da trockenes Holz zu kleineren Rissen führen kann. OBS! Denken Sie daran, dass es wichtig ist, dass das Material vor der Ölbehandlung trocken und sauber ist.

**Aintwood:** Dieses Material sieht aus wie Holz, besteht aber aus Kunststoff, um besser zu unserem skandinavischen Klima zu passen. Kunststoff ist empfindlich gegenüber höheren Temperaturen. Daher sollten Möbel aus Aintwood nicht in einem unbelüfteten, verglasten Bereich aufgestellt werden, wo die Temperatur wärmer werden kann. Dadurch kann das Material weich und verformt werden. Orte, die man im Sommer meiden sollte, sind Gewächshäuser und verglaste Veranden. Es ist wichtig, sich daran zu erinnern, dass Sonnenlicht, das in Glas reflektiert wird, einen brennenden Effekt erzeugt. Lassen Sie daher niemals Glasgegenstände unbeaufsichtigt auf der Aintwood-Oberfläche liegen, da Brandlöcher entstehen können. Um dies zu vermeiden, verwenden Sie immer Untersetzer und entfernen Sie Gläser, wenn sie nicht verwendet werden.

**Polyester:** Dieses Material wird für fast alle unsere Kissen und Schirme verwendet und sollte nicht in der Maschine gewaschen werden. Wir empfehlen stattdessen Handwäsche. Da Polyester bei direkter Sonneneinstrahlung ausbleichen kann, empfehlen wir die Auflagen / Schirme immer z.B. Kissenschachteln oder unter Möbelbezügen, wenn sie nicht verwendet werden. Dies soll die Haltbarkeit verlängern und Verfärbungen vermeiden.

Wir hoffen, Sie haben viele schöne Sommermomente in Ihren neuen Möbeln!





Congratulations on your new outdoor furniture!

It is important to know how to best take care of your furniture. We recommend you go to [www.venturdesign.se](http://www.venturdesign.se) and find "Care Advice" to get mor detailed information. On this sheet you will find general tips and tricks for different materials.

**Steel:** Keep in mind that steel is a material that can rust when getting exposed to water and moisture over a longer time. It is important to try and keep the steel furniture dry, by using a furniture cover for example. Rust from inside or on the furniture can drip and discolour the surface it is standing on. Remember that if placing it on your new wooden terrace.

**Aluminum - Aluminum** is a lighter material than steel and makes your furniture light and flexible, this material should not rust either. However, some parts of your furniture may still be made of steel (for example screws or fittings)

**Artificial Rattan (Wicker):** This material is incredibly grateful and requires little care to maintain a good condition. The material is UV-resistant and can withstand weather and wind. It is important to remember that wicker is made of plastic and therefore behaves accordingly - expands and shrinks depending on temperature. Wicker will expand and get loose when it is warm but will then contract again when it gets colder.

**Teak:** Our teak furniture is produced from cultivated teak i.e., teak that is grown for the purpose of becoming furniture or something else. This means it has not contributed to the deforestation of the tropical rain forests. Of course, it is also FSC-certified. In order to keep the finish and colour of your teak, it should be treated with teak oil. If this is not done, the teak gets the characteristic grey colour that can almost be compared to driftwood. We always recommend to treat teak, as dry wood can lead to smaller cracks. OBS! Keep in mind that it is important that the material is dry and clean before oil treatment.

**Aintwood:** This material looks like wood but is made of plastic to better fit for our Scandinavian climate. Plastic is sensitive to higher temperatures. Therefore, furniture in aintwood should not be placed in an unventilated, glazed area where the temperature can rise to warmer degrees. This can make the material soft and deformed. Places to avoid in the summer are greenhouses and glazed porches. It is important to remember that sunlight reflected in glass creates a burning effect. Therefore, never leave any glass objects unattended on the aintwood surface, as burn holes can be created. To avoid this, always use coasters and remove glasses when not used.

**Polyester:** This material is used for almost all our cushions and umbrellas and should not be machine washed. We recommend hand washing instead. As polyester can be bleached in direct sunlight, we recommend always storing the cushions / umbrellas in e.g. cushion boxes or under furniture covers when not used. This is to extend the durability and avoid discoloration.

We hope you have many wonderful summer moments in your new furniture!

OBS!

*Please be careful when assembling, if screws are tightened too hard (or by screwdriver), damages in the table top may appear. Tighten the screws after some time of using the product.*





# EXPLODED VIEW

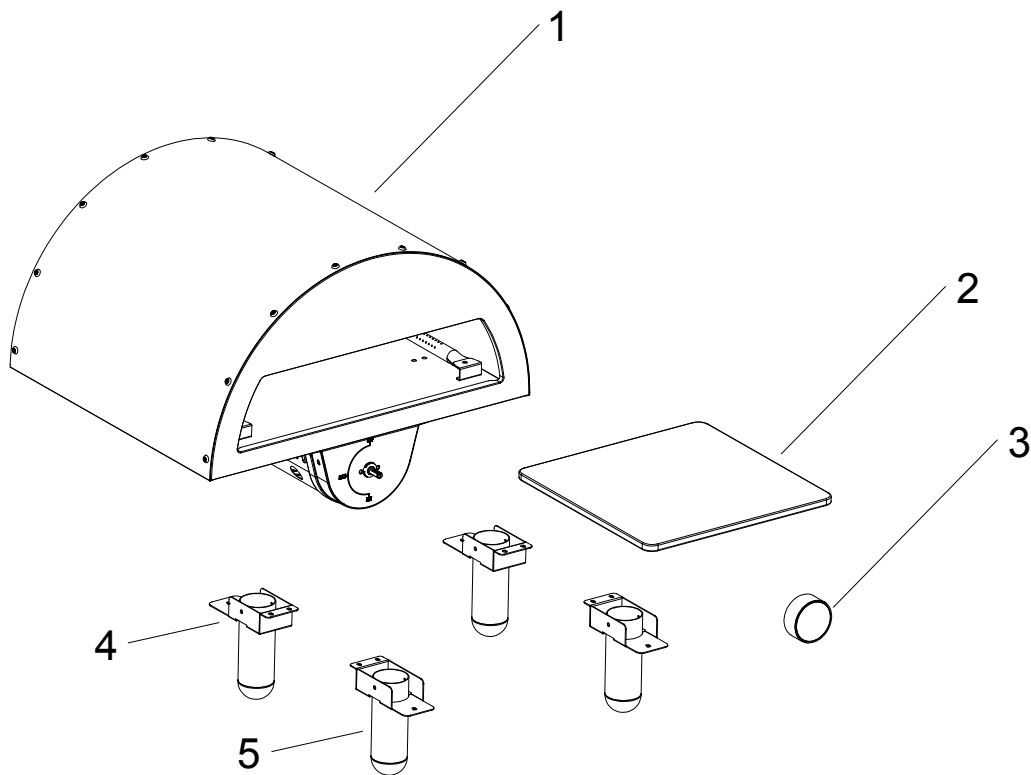

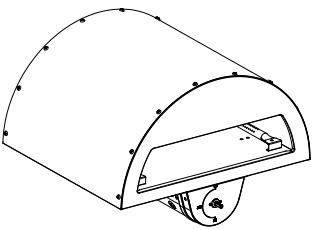
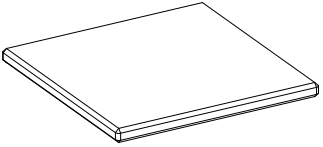
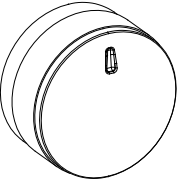
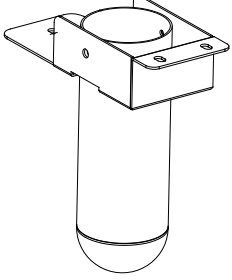
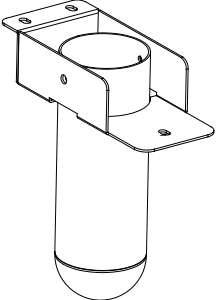
<p>1. Body ..... 1pc</p> 	<p>2. stone baking board ....1pc</p> 	<p>3. Knob....1 pc</p> 	<p>4. foot-A</p> 
<p>5. foot-B</p> 			

Do not tighten screws until all screws have been assembled !

# HARDWARE PACK CONTENTS

A	Bolt: M4x10 	12pcs			
---	--	-------	--	--	--

## ASSEMBLY INSTRUCTIONS

### ASSEMBLY TIPS

- Remove all contents from packaging, and make sure all the parts are present before attempting to assemble!
- Tighten all bolt connections by hand first.
- When the BBQ is fully assembled, retighten the screws, nuts and bolts by using a wrench and screw driver.

### TOOLS REQUIRED

- Philips screwdriver
- Pliers or adjustable spanner

### STEP 1

Assemble the Foot A (part 4) onto the Body (part 1) as shown. Use the Bolt A to tighten it. Assemble the Foot B (part 5) onto the Body (part 1) as shown. Use the Bolt A to tighten it. Insert the Knob (part 3) on the Body as shown.

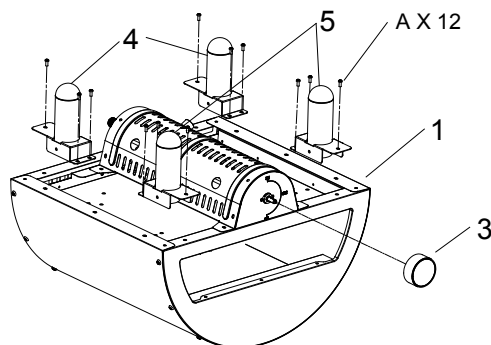

### STEP2

Put the AA battery into the battery box as shown in the figure

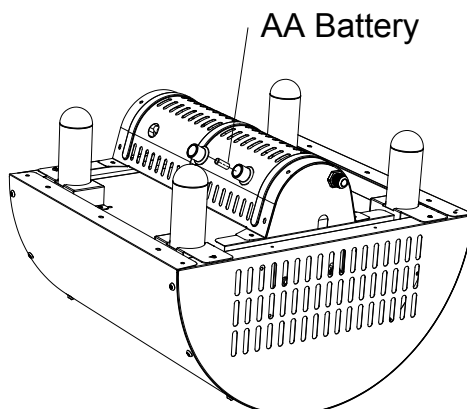

Do not tighten screws until all screws have been assembled !



@Venturehomese  
@Venture.Design

Venture  
home



STEP4  
Finish

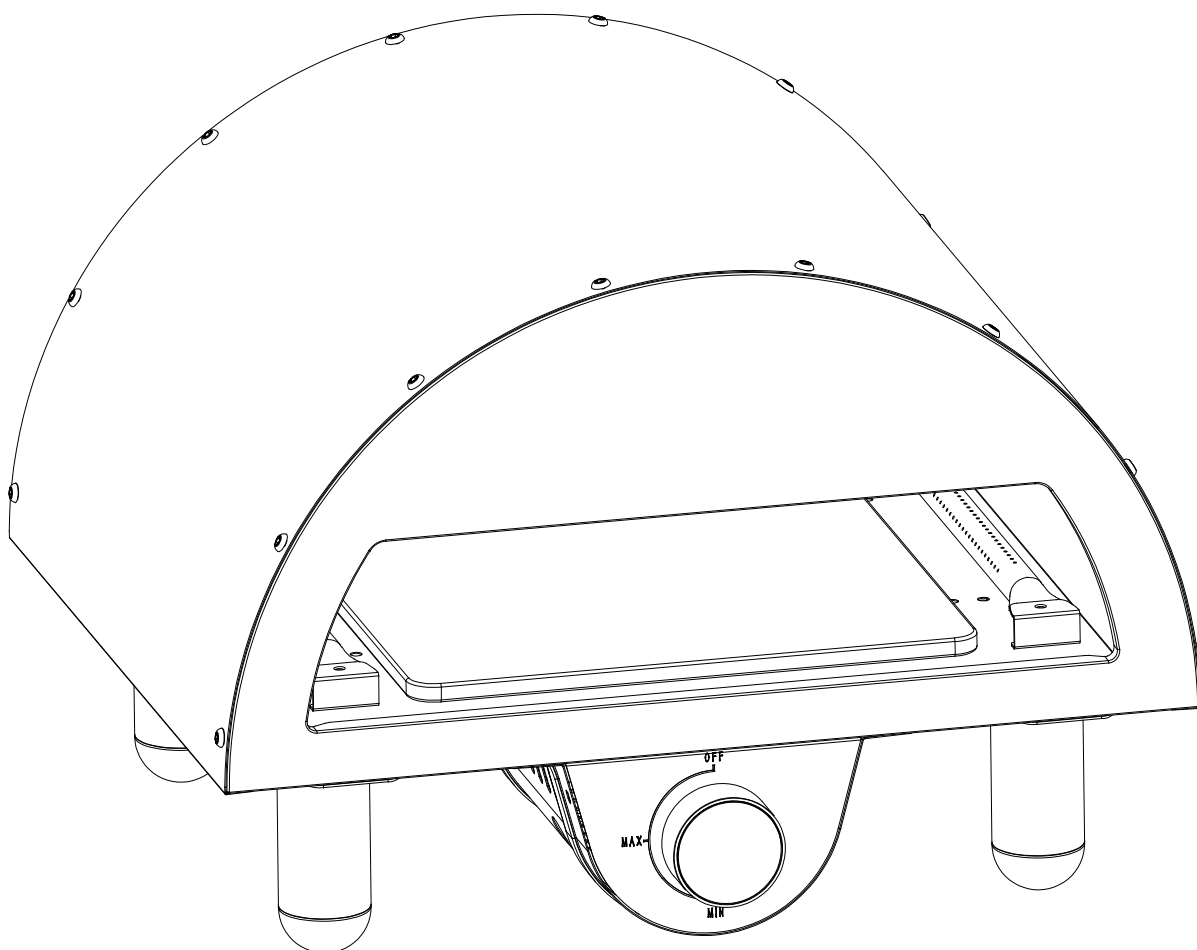

@Venturehomese  
@Venture.Design

Do not tighten screws until all screws  
have been assembled !

**Venture  
home**



# ASSEMBLY & OPERATION INSTRUCTIONS

**IMPORTANT!**  
**PLEASE READ THESE INSTRUCTIONS CAREFULLY BEFORE**  
**USING**  
**THE APPLIANCE!**

**READ THE ASSEMBLY INSTRUCTIONS IN THIS BOOKLET**  
**BEFORE REMOVING THE CONTENTS OF THIS CARTON**



#### FOR YOUR SAFETY

If you smell gas:

1. Shut off gas to the appliance.
2. Extinguish any open flame.
3. Open lid.
4. If odour continues, immediately call your gas supplier.

#### FOR YOUR SAFETY

1. Do not store or use gasoline or other flammable vapours or liquids in the vicinity of this or any other appliance.
2. A gas cylinder not connected for use shall not be stored in the vicinity of this or any other appliance.



- For outdoor use only. Do not use indoors.
- Improper installation, adjustment, alteration, service or maintenance can cause property damage, injury or death.
- Read the installation, operating and maintenance instructions thoroughly before installing or servicing this equipment.
- **WARNING!** This BBQ will become very hot, do not move it during operation.
- **Warning:** Accessible parts may be very hot. Keep children and pets away
- Never leave a lighted BBQ unattended.
- Only use the BBQ on a level surface.
- Turn off the gas supply at the gas cylinder after use.
- Any modification of the appliance may be dangerous and will void the warranty.
- Installer to leave instructions with the consumer and consumer to retain them for future reference.
- Do not replace the grill with an extra hotplate. The warranty will be voided and it is in violation of the gas approval. The grill provides the ventilation needed for the BBQ to operate safely. It is not designed to be a solid hotplate device.
- Please ensure all packaging and transit protection materials are removed prior to using the BBQ.
- Do not use the BBQ in a confined or enclosed space such as a garage, carport, tent, marquee, to avoid risk of fire and the accumulation of smoke and fumes.



@Venturehomese  
@Venture.Design

Do not tighten screws until all screws  
have been assembled !

**Venture  
home**



# SAFETY INSTRUCTIONS

IMPORTANT: READ THE ASSEMBLY INSTRUCTIONS IN THIS BOOKLET BEFORE REMOVING THE CONTENTS OF THIS CARTON

## IMPORTANT SAFETY INSTRUCTIONS

**This appliance must only be used in an above ground open-air situation with natural ventilation, without stagnant areas, where gas leakage and products of combustion are rapidly dispersed by wind and natural convection**

- This BBQ is an **outdoor appliance only**. Under no circumstances should it be use indoors.
- READ ALL OPERATING INSTRUCTION BEFORE LIGHTING
- Do not perform any servicing on the BBQ yourself. This includes internal adjustment of the regulator and gas valves. Servicing can only be carried out by authorized technicians.
- When gas cylinder is replaced or reconnected, check for leaks.
- Do not store chemicals or flammable materials near this appliance.
- Unsupervised children should not be near a BBQ while cooking or during warm up or cool down.
- People with flammable clothing such as nylon etc. should keep well away from the BBQ when it is operating.
- Do not leave food unattended on the BBQ.
- In case of fat fire, turn gas cylinder off.
- Particular care must be taken when removing the drip tray. Hot oil can cause serious injury.
- This BBQ should not be located under overhead combustible construction and proper clearances must be maintained at all times from combustible construction and/or materials, with **MINIMUM** clearances as follow:

From Sides	450mm
From Back	450mm
High	1000mm
- Turn all gas valves off including gas cylinder after use.
- Never leave burners on high for more than 10 minutes unless actually cooking. If the burner makes hissing sound when lit, it may be burning inside. Turn burner off, allow it to cool and try again.
- Do not allow build up of unburned gas.
- Remove sticker from hood before use.
- Drip tray needs to be cleaned regularly to prevent excessive fat or grease build up that



**DO NOT** OPERATE THIS APPLIANCE BEFORE READING THEINSTRUCTION BOOKLET  
**DO NOT** PLACE ARTICLES ON OR AGAINST THIS APPLIANCE  
**DO NOT** STORE CHEMICALS OR FLAMMABLE MATERIALS OR SPRAYAEROSOLS NEAR THIS APPLIANCE  
**DO NOT** OPERATE THIS APPLIANCE INDOORS  
**DO NOT** ENCLOSE THIS APPLIANCE

## WARNING

A strong gas smell or the hissing sound of gas indicates a serious problem with your gas BBQ or the gas cylinder. Failure to immediately follow the steps listed below could cause serious bodily injury, death, or property damage.

- Shut off gas supply to the gas BBQ.
- Turn the control knobs to OFF position.
- Put out any flame with a class B fire extinguisher.
- Get away from the gas cylinder.
- Do not try to fix the problem yourself.

If odour continues or you have a fire you cannot extinguish, call your fire department. Do not call near the gas cylinder because your telephone is an electrical device and could create a spark resulting in fire and/or explosion.

**NOTE:** The normal flow of gas through the regulator and hose assembly can create a humming sound. A low volume of sound is perfectly normal and will not interfere with operation of the BBQ. If humming sound is loud and excessive you may need to purge air from the gas line or reset the regulator excess gas flow device. This purging procedure should be done every time a new gas cylinder is connected to your BBQ.

## OTHER CONSIDERATIONS

- Strong winds and low temperatures can affect the heating and performance of your gas BBQ so factor in these elements when positioning your BBQ outdoors for cooking.
- Never use your gas BBQ in a garage, porch, shed, breezeway or any other enclosed area.
- Your gas BBQ is to be used outdoors only, at least 45cm from the back and side of any combustible surface. Your BBQ should not be placed under any surface that will burn.
- Do not obstruct the flow of ventilation air around the gas BBQ housing. This gas BBQ is not intended to be installed in or on recreational vehicles and/or boats.

## INSTALLATION COMPLIANCE

This appliance must be installed in accordance to the installation instructions provided by the manufacturer, local gas fitting regulations, municipal building codes and any other relevant statutory regulations

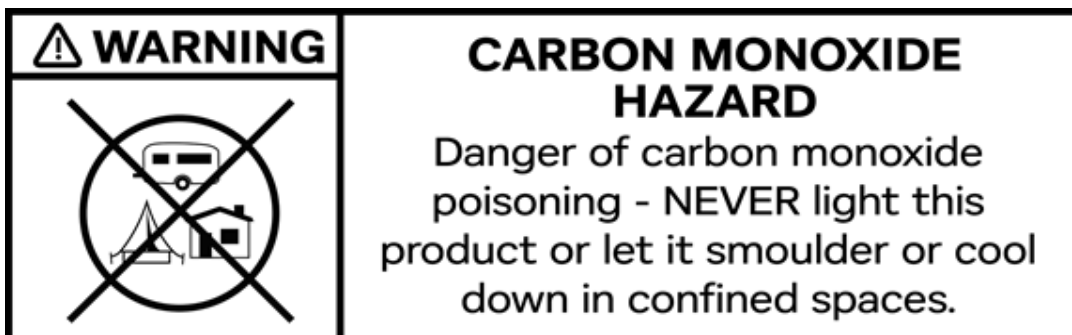

@Venturehomese  
@Venture.Design

Do not tighten screws until all screws  
have been assembled !

Venture  
home



## PLACEMENT OF BBQ

### PLACEMENT OF BBQ

- This product is meant for outdoor use only! Do not store petrol or any inflammable liquids near this product.
- Always place the gas cylinder beside the BBQ when not in use. Some models have room for a gas bottle underneath the burners – this is only to be used when the BBQ is cold!

### NOTE:

Wrongful installation, adjustments and changes, or lack of service and maintenance could cause damage to individuals or materials. It is therefore important to carefully read the instructions on how to install, use and maintain the product before assembling the item. The BBQ must be installed according to national/local regulations. Make sure that the gas hose is not clenched, and never in contact with hot surfaces, and that the BBQ is installed in exact accordance with these instructions. For service, please contact authorized personnel. Always ensure that the BBQ is placed away from inflammable material when being used. When lighted, the BBQ must be kept under surveillance at all times. Keep children at a safe distance from the BBQ; touching hot surfaces could cause burns. The BBQ must be kept clean to avoid flare-ups caused by remnants of fat. Fires resulting from ignition of grease will void the warranty. Ensure that the gas cylinder is suitable for your product.

### ANY ENCLOSURE IN WHICH THE APPLIANCE IS USED MUST COMPLY WITH ONE OF THE FOLLOWING:

An enclosure with walls on all sides, but at least one permanent opening at ground level and no overhead cover. Within a partial enclosure that includes an overhead cover and no more than two walls. Within a partial enclosure that includes an overhead cover and more than two walls, the following shall apply-

- at least 25% of the total wall area is completely open; and
- at least 30 %of the remaining wall area is open and unrestricted.

In the case of balconies, at least 20%of the total of the side, back and front wall areas shall be and remain open and unrestricted.

Outdoor area example 1

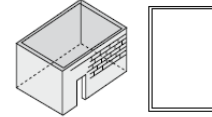

Outdoor area example 2

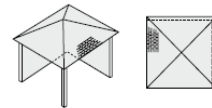

Outdoor area example 3

both ends open

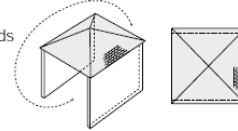

Outdoor area example 4

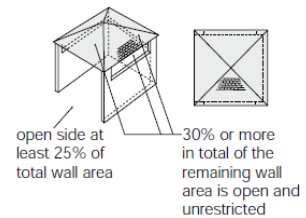

Outdoor area example 5

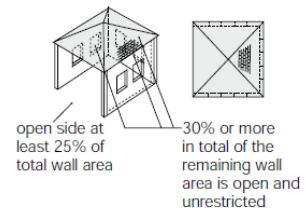

# GAS CYLINDER SAFETY INFORMATION

## GAS TYPE

Note the labeling of appropriate gases listed on your BBQ and ascertain that the gas you have is suitable for your BBQ. Be aware that several different valves for gas cylinders exist, and that the regulator must connect appropriately to your gas cylinder.

## GAS CONNECTION

- Never try forcing the gas cylinder valve to fit the gas regulator.
- Never make adjustments to low-pressure regulator and hose coupling.
- The gas hose must be inspected for signs of damage/leakage prior to being used. If any of these parts are being replaced, use only parts specified by the manufacturer.
- The regulator and gas hose should be secured by using hose clamps, which are tightened with the use of a screw driver.
- Do not secure any attachments with tape, or similar materials not meant for gas applications.
- When the gas cylinder is not in use, it must be turned off and disconnecting the regulator is advisable.

## HOSE AND REGULATOR REPLACEMENT

In the case of a problem arising with the hose and regulator please contact your BBQ supplier for a list of approved replacement parts. The hose and regulator assembly parts must comply to CE gas standards.

## GAS CYLINDER STORAGE

Gas cylinder not in use are to be stored outdoors in a well ventilated place, out of reach from children. Make sure that the gas cylinder is placed in an upright position and on an evenly surfaced ground. Additional gas cylinder are not to be stored underneath or in proximity to the BBQ.

## SAFETY WHEN LEAKAGE OF GAS IS SUSPECTED

- Turn off the BBQ's gas supply and disconnect the regulator from the gas cylinder.
- Wipe out any open flames and remove possible ignition sources. If the smell of gas is sustained, please contact your gas supplier or the fire department immediately.
- If the gas cylinder appears to be the source of smell/leakage, place this outdoor with good ventilation and away from possible ignition sources



## WARNING

**STORE GAS CYLINDER IN A WELL VENTILATED AREA  
OUT OF REACH OF CHILDREN**



## LEAK TESTING

Please check for gas leakage the first time you are connecting the BBQ to the gas cylinder, and also each time you are replacing the gas cylinder or disconnecting/reconnecting any fittings. Inspect the hose before each use.

To check for gas leakage, turn on the gas supply at the gas cylinder, but do not switch on the burners inside the BBQ. The gas hose will now be filled with gas. Then pour water with soap over all connections. Any gas leakage should result in bubbles within 20 seconds. If a gas leakage is detected, tighten the connection. If the gas leakage persists, contact your supplier or place of purchase. As an alternative, you may use a gas leak detector, following the manufacturer's instructions, available at all major BBQ retailers. This provides an easier way to check for gas leaks

**DO NOT USE NAKED FLAME FOR LOCATING GAS LEAKS. IF A LEAK PERSISTS, CALL AN AUTHORISED PERSON**

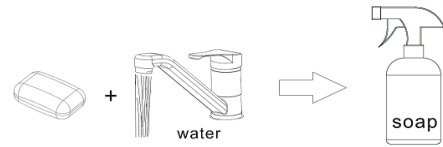

1. Add soap and water to spray bottle or soapy water with brush

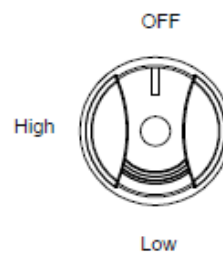

2. Turn off gas valves



3. Turn gas cylinder on

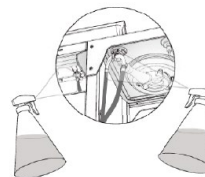

4. Spray or apply soapy water on gas connections

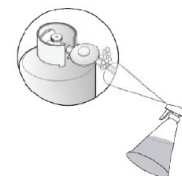

5. If leak is present, bubbles will appear



@Venturehomese  
@Venture.Design

Do not tighten screws until all screws have been assembled !

Venture  
home



### LIGHTING PROCEDURE

- Lighting the BBQ is easy, but must be done with due care.
- Make sure that gas is turned on at the cylinder, or that gas is available to the BBQ.
- Make sure the gas cylinder is filled.
- Check that the end of each burner tube is properly located over each valve orifice.
- Make sure all gas connections are securely tightened.

### FLAME THROWER IGNITION

This BBQ is equipped with automatic ignition, as indicated on the front fascia of the BBQ frame. It works by throwing a flame to the side of the burner to light. Push the knob in and turn anticlockwise to the high position. You should hear and feel a click from the knob. Hold the knob in until the burner ignites. If the burner does not light on the first attempt, return the knob to the "OFF" position and try a couple more times. If the burner still does not light, wait a few minutes to allow the gas to disperse before trying again.

### MANUAL IGNITION

- Place a lighted match or gas lighter (not provided).
- Keep your hand below the bottom of the burner while doing this.
- Turn the burner on.
- You should see the burner alight.
- Repeat to light the other burners.

### TURNING OFF THE BBQ

- When finished cooking, leave the burners at the "HIGH" position up to 5 minutes so that remaining grease from the food will be removed.
- When turning off the BBQ, close the supply from the gas cylinder first; this will allow the gas remaining in the hose to evaporate. This will only require a few seconds. The burners can then be switched off.

### CONTROLLING THE FLAMES

The knobs have three basic positions. You can achieve any flame height between low and high by rotating the knob between these positions.

Burner off

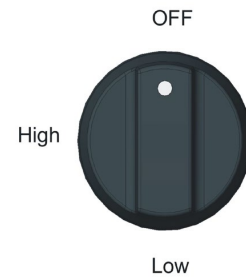

Burner on high

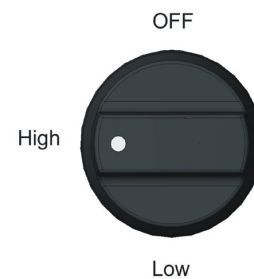

Burner on low

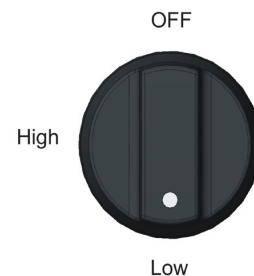

**Note:** 'Blowback' is a situation where the flame burns inside the burner, towards the front, recognised by a sharp roaring sound coming from the burner. It is not dangerous unless allowed to persist. If this occurs, simply turn the burner off, wait a few seconds, and then relight.



### **FIRST TIME USE - CURING THE PLATE**

During manufacturing, the cooking surface is coated with a non-toxic paint. This paint will come off completely over time. Its purpose is purely to help protect your BBQ during transport and storage.

Coat the cooking surface with canola oil or cooking oil. Light the BBQ. Leave the BBQ with all burners on low for about 30 minutes. Paint may come off at this time. After cleaning, the cooking surface is now cured and ready for use. This process only needs to be done the first time you use the BBQ

### **PREPARING THE COOKING SURFACE**

It is recommended to coat the cooking surface with cooking oil before lighting as this will help keep the food from sticking to the cooking surface. Turn on the burners and leave them burning at a low temperature ("LOW") to preheat the cooking surface

### **WHILE COOKING**

Flames caused by fat dripping from the food could damage the food, causing the food to burn easily. Remove excess fat from the meat if this becomes a problem. Removing the meat from the flames is also advisable. Always monitor your cooking and avoid leaving the BBQ unattended while cooking.

### **AFTER COOKING**

To turn the BBQ off, it is best to turn off the cylinder first, and allow all the gas remaining in the hose to burn off, this will only take a couple of seconds. Then turn off all burners.

### **DRIP TRAY**

Drip tray must be cleaned regularly and checked each time before use. Always empty drip tray before each use. Overflow of the drip tray might cause serious burns or injuries. Never touch the drip tray until the BBQ and fat have cooled down completely. Fat fire from excessive fat or grease build up is not covered by warranty.

### **COOKING SURFACE MAINTENANCE**

Burning at maximum heat for approximately 5-10 minutes is recommended after each use to clean the cooking surface. Remnants of food and grease can then be removed using a brush. You should use an oven mitt to avoid burning yourself. Then recoat the plate with cooking oil for continued protection.

NOTE: The cooking surface should be coated with cooking oil if the BBQ is not to be used for a longer period of time. Failure to do this will result in a layer of rust on the surface.

### **CARING FOR THE BBQ**

Your BBQ should be kept clean to prevent deterioration and it will look better and last longer if you keep the BBQ clean.

The BBQ should be regularly cleaned and be protected by a fitted cover when not in use. Clean the BBQ thoroughly on a regular basis, and cover it with a thin layer of neutral oil (acid free oil).

Grease can build up on the frame itself. Most of it can be cleaned off with hot water. Use a non-caustic cleanser for more stubborn stains.

Movable parts such as the hinges, wheel nuts and doors should be sprayed with a lubricant.

### **REMINDER**

Always ensure that the appliance has cooled down before cleaning. Hot surfaces may cause serious burns or injuries. If appliance is still hot, use oven mitts to protect your hands.



@Venturehomese  
@Venture.Design

Do not tighten screws until all screws have been assembled !

**Venture  
home**



## BBQ MAINTENANCE

Apart from cleaning, your BBQ is a fairly low maintenance appliance. Below are a couple of things worth looking at though. Remember to turn off and disconnect the gas before any maintenance is carried out.

- If your BBQ uses a flexible hose to connect to the gas, check the rubber O-ring on the regulator end of the hose assembly at least once a year. If it appears worn or cracked, have it replaced. The flexible hose is 800mm in length.
- We recommend having your BBQ checked by an authorized service agent every 5 years. This is to ensure there are no leaks and that all components are still functioning correctly.
- If you use a portable gas cylinder, you will need to have the cylinder serviced or replaced every ten years. The date of the last service should be stamped on the neck of the bottle.
- Keep the outdoor BBQ area clear and free from combustible materials, gasoline, and other flammable vapours or liquids.
- Make sure there is no obstruction surrounding the BBQ, which may block the flow of combustion and ventilation air.
- To maintain the surface of your hotplate, it is recommended to keep the hotplate plate oiled at all times and covered when not in use. A BBQ cover is also recommended to protect your BBQ from all weather conditions.

## IMPORTANT INFORMATION

- This product is for outdoor use only.
- Do not use indoors.
- Do not use below ground level.
- Do not store gas cylinders below ground level.
- Gas is heavier than air so if a leak occurs the gas will collect at a low level and could ignite in the presence of a flame or spark.
- Do not store or use gas cylinders on their side as this could allow liquid gas into the supply pipes with serious consequences.
- Leak test your BBQ before each use. Leak test the hose connections each time you reconnect the gas cylinder.
- Always turn off the gas at the cylinder when not in use.
- Open the door of the frame to inspect the hose before each use. If there is evidence of excessive abrasion or wear, or the hose is cut it must be replaced prior to the BBQ being put into operation.
- Only use hose supplied from the manufacturer.

**You must have the correct gas cylinder, regulator and hose for BBQ to operate safely and efficiently. Use of an incorrect gas cylinder, regulator or hose is dangerous and will void the warranty on this product.**



@Venturehomese  
@Venture.Design

Do not tighten screws until all screws  
have been assembled !

Venture  
home



## BURNER MAINTENANCE

You should check the burners periodically for any sort of blockage. To do this, remove and inspect them. If any of the holes are clogged, gently tap the burner onto a hard surface to remove residue. Use a wire brush to unclog the holes. Once this is done, lightly coat the burners with oil to help protect them from rust.

To reduce the chance of "FLASH-BACK", the procedure below should be followed at least once a month in late summer or early fall when spiders are most active or when your BBQ has not been used for a period of time.

1. Turn all burner valves to the full OFF position.
2. Turn the gas cylinder valve (clockwise) to the full OFF position.
3. Detach the regulator assembly from the gas cylinder.
4. Remove all burners from the bottom of the BBQ. Use a screwdriver or needle nose pliers.
5. Carefully lift each burner up and away from the gas valve orifice.
6. Refer to figure below and perform one of these three cleaning methods.

Bend a stiff wire, (a lightweight coat hanger works well) into a small hook as shown below. Run the hook through the burner tube and inside the burner several times to remove any debris.



Use a bottle brush with a flexible handle. Run the brush through the burner tube and inside the burner several times, removing any debris.

Use an air hose to force air through each burner tube. The forced air should pass debris or obstructions through the burner and out the ports.

1. Regardless of which burner cleaning procedure you use, we recommend you also complete the following steps to help prolong burner life.
2. Use a wire brush to clean the entire outer surface of each burner until free of food residue or dirt
3. Clean clogged ports with wire, such as an open paper clip.

Inspect each burner after installation, check to ensure that the gas valve orifices are correctly placed inside the end of the burner tubes. Also check the position of your spark electrode.

USE ONLY THE HOSE AND REGULATOR PROVIDED!

If a replacement is necessary, please contact your local supplier.

The use of unauthorized parts can create unsafe conditions and environment.

<h1>Kerang Pizzaoven</h1>		 2806-22	
Total Heat Input	4.4 kW x 1 = 4.4 kW (313g/h)		
Gas Category	I <sub>3B/P(30)</sub>	I <sub>3+(28-30/37)</sub>	I <sub>3B/P(50)</sub>
Types of Gas and Gas Pressure	Butane and Propane 28-30 mbar	Butane at 28-30mbar Propane at 37mbar	Butane and Propane At 50mbar
Countries of Use	BE,CY,DK,EE,FR,GB, HU,IT,LT,NL,NO,SE,SI,SK,RO,HR ,TR,BG, IS,LU,MT,FI	BE,CH,CY,CZ, ES,FR, GB,GR,IE,IT,LT ,LU, LV,PT,SK,SI.	AT,CH,DE,SK
INJECTOR SIZE:	Grill:1.05	Grill:1.05	Grill:0.9
IDENTIFICATION CODE:	2806DM0100		
FOR USE OUTDOORS AND IN WELL VENTILATED AREAS			
WARNING: ACCESSIBLE PARTS MAY BE VERY HOT. KEEP YOUNG CHILDREN AWAY			
READ THE INSTRUCTION LITERATURE BEFORE USING THE APPLIANCE.			

Close the valve of the gas cylinder or the regulator after use.

The use of this appliance in enclosed areas can be dangerous and is PROHIBITED.

The appliance must use an EN16129 approved gas regulator and EN16436-1 approved gas hose with a length of at least 1 meter. You will need to purchase them from your local gas dealer if not supplied.

The side burner must be use the minimum pot sizes 200mm.