

# Jotex

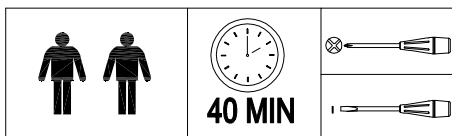

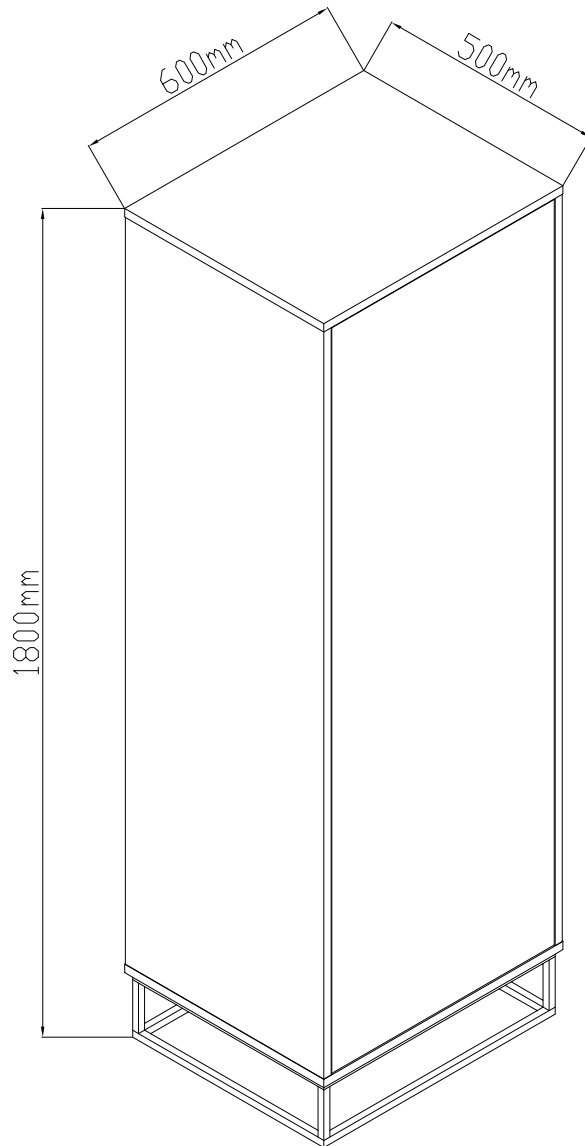

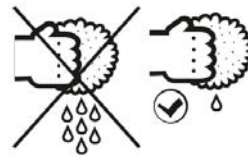

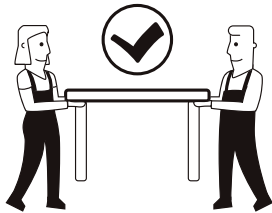
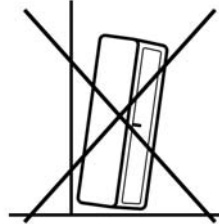
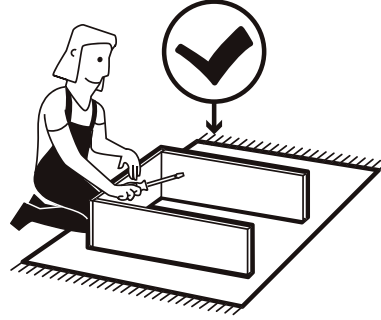
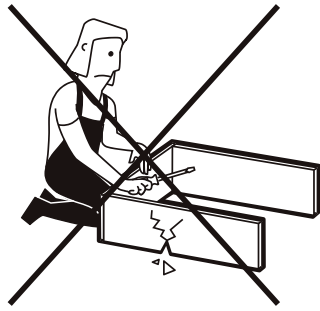

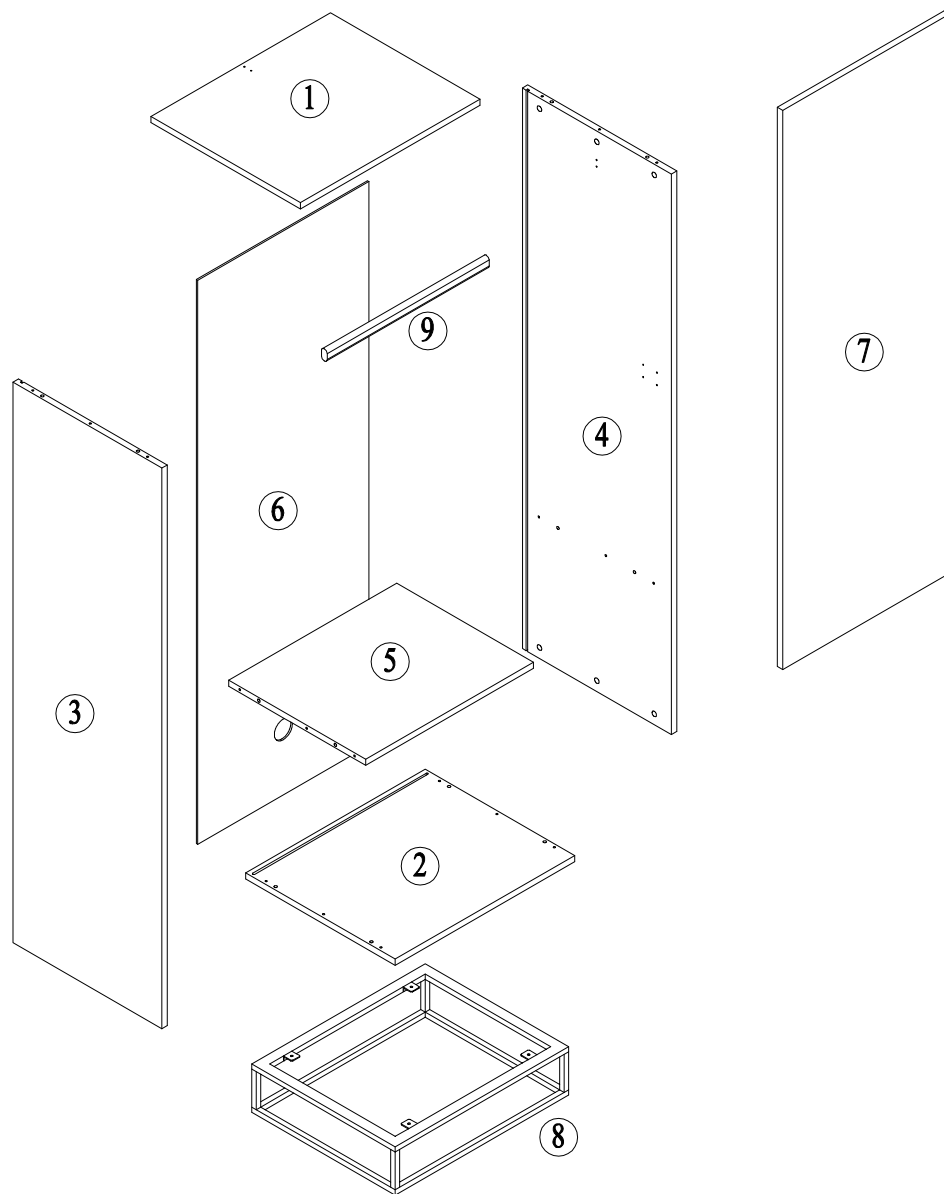

1741791



Max loading weight:  
10kgs on shelf  
15kgs for hanger

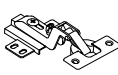

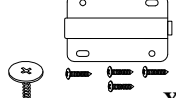

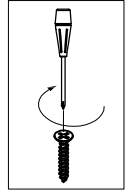
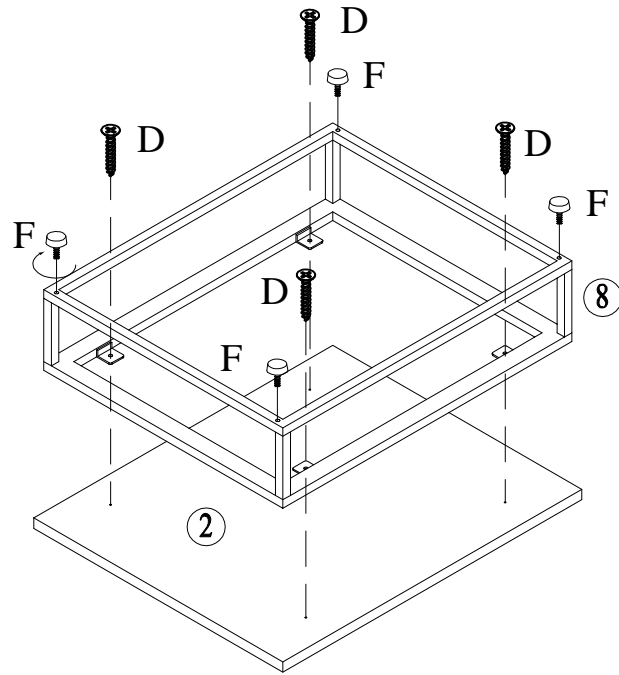

<p><b>A</b></p>  <p>Ø15x12mm x 18</p>	<p><b>B</b></p>  <p>Ø6.5 x 38mm x18</p>	<p><b>C</b></p>  <p>Ø8 x 30mm x12</p>	<p><b>D</b></p>  <p>M4 x 16mm x34</p>	<p><b>E</b></p>  <p>M3 x 16mm x8</p>
<p><b>F</b></p>  <p>x4</p>	<p><b>G</b></p>  <p>x4</p>	<p><b>H</b></p>  <p>x1</p>	<p><b>I</b></p>  <p>x1</p>	<p><b>J</b></p>  <p>x8</p>
<p><b>K</b></p>  <p>x2</p>				

1



<p>F</p>  <p>x4</p>	<p>D</p>  <p>M4 x 16mm</p> <p>x4</p>
--	--

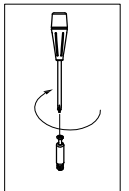
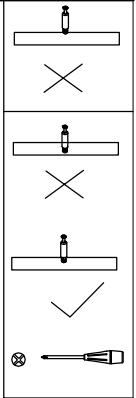
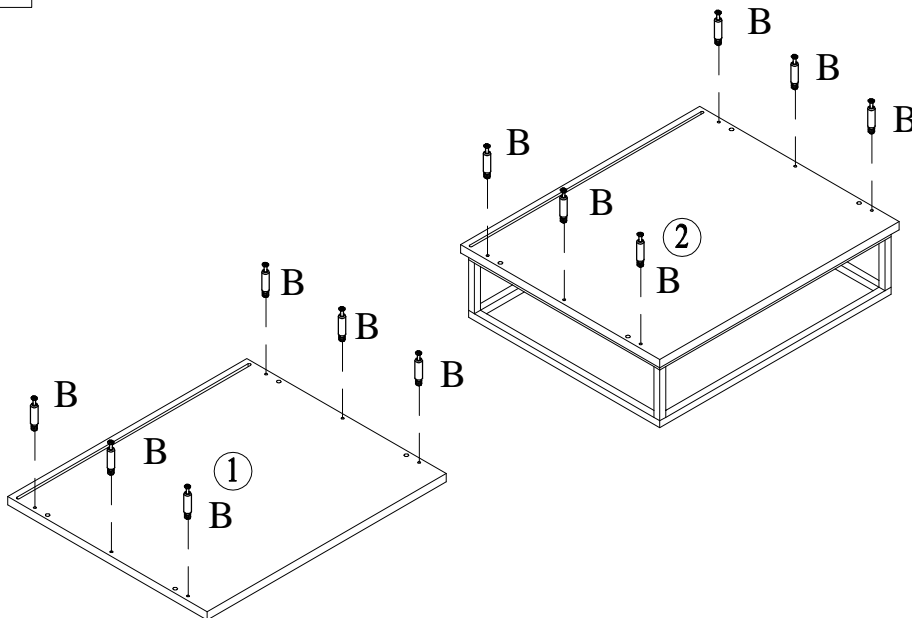

2

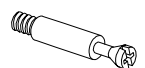

<p>B</p>  <p>Ø6.5 x 38mm</p> <p>x12</p>
--

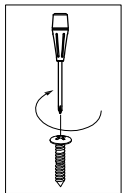
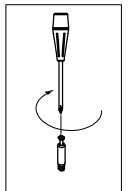
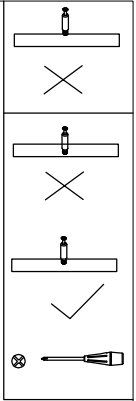
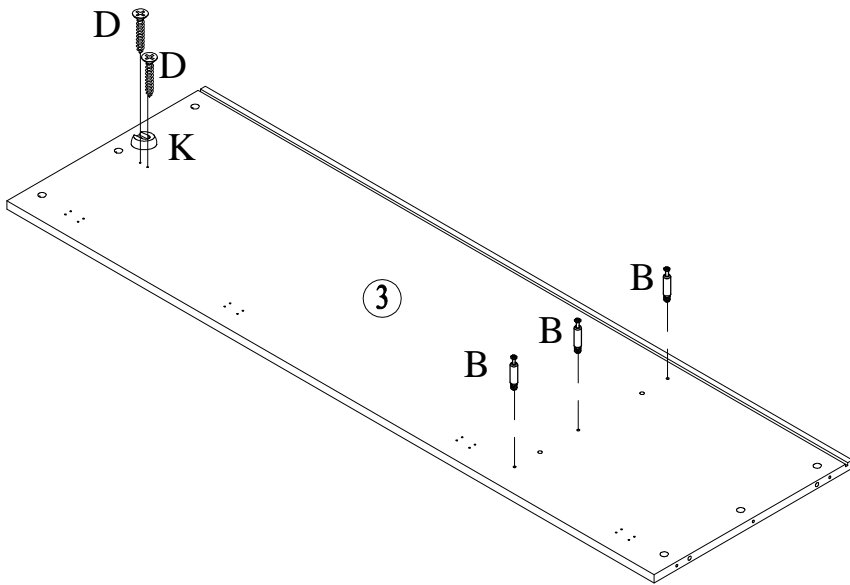
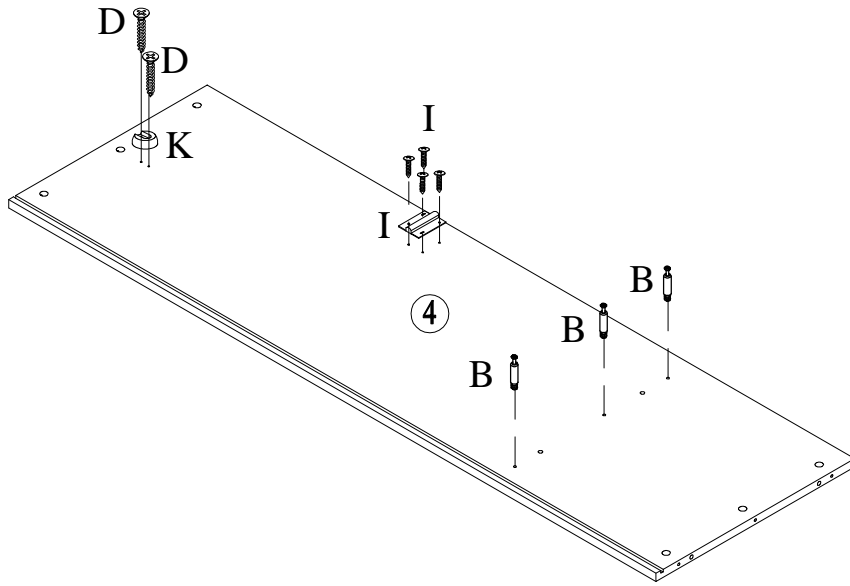
3

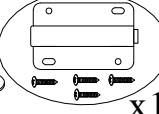
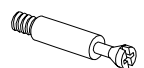

<p><b>D</b></p>  <p>M4 x 16mm</p> <p>x4</p>	<p><b>K</b></p>  <p>x2</p>	<p><b>I</b></p>  <p>x1</p>	<p><b>B</b></p>  <p>Ø6.5 x 38mm</p> <p>x6</p>
--	---	---	--

4

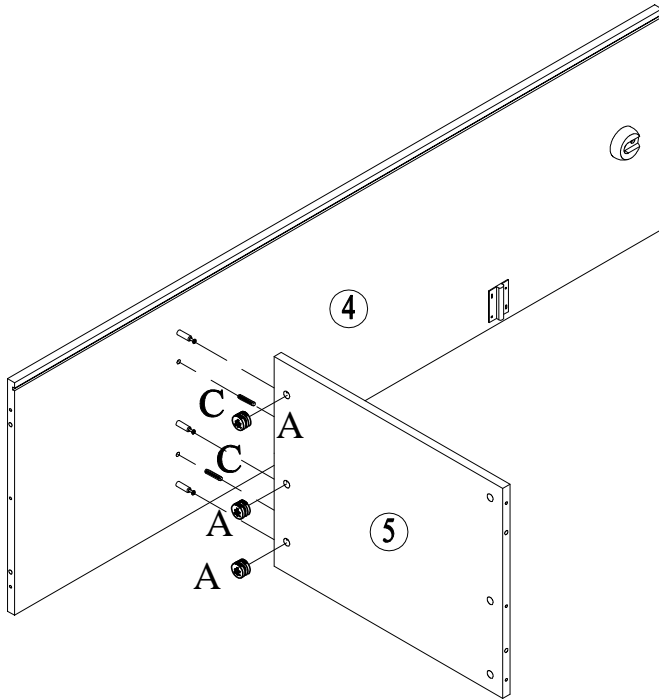

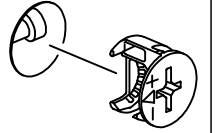

1

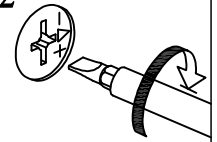

2



<b>C</b>  Ø8 x 30mm x2	<b>A</b>  Ø15x12mm x3
--	---

5

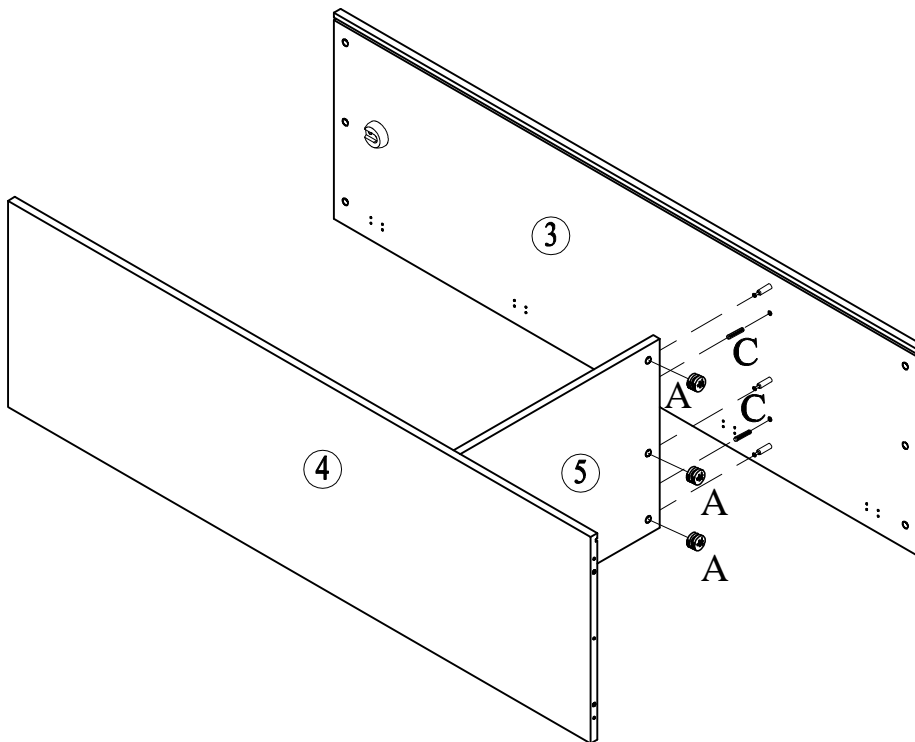

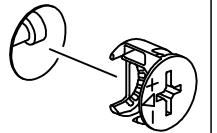

1

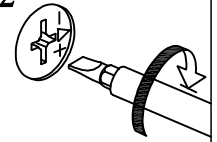

2



<b>C</b>  Ø8 x 30mm x2	<b>A</b>  Ø15x12mm x3
--	---

6

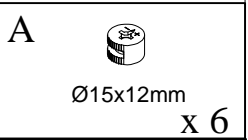
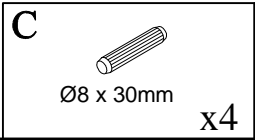
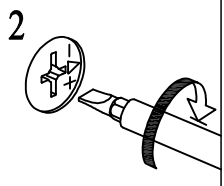
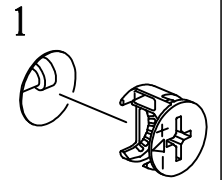
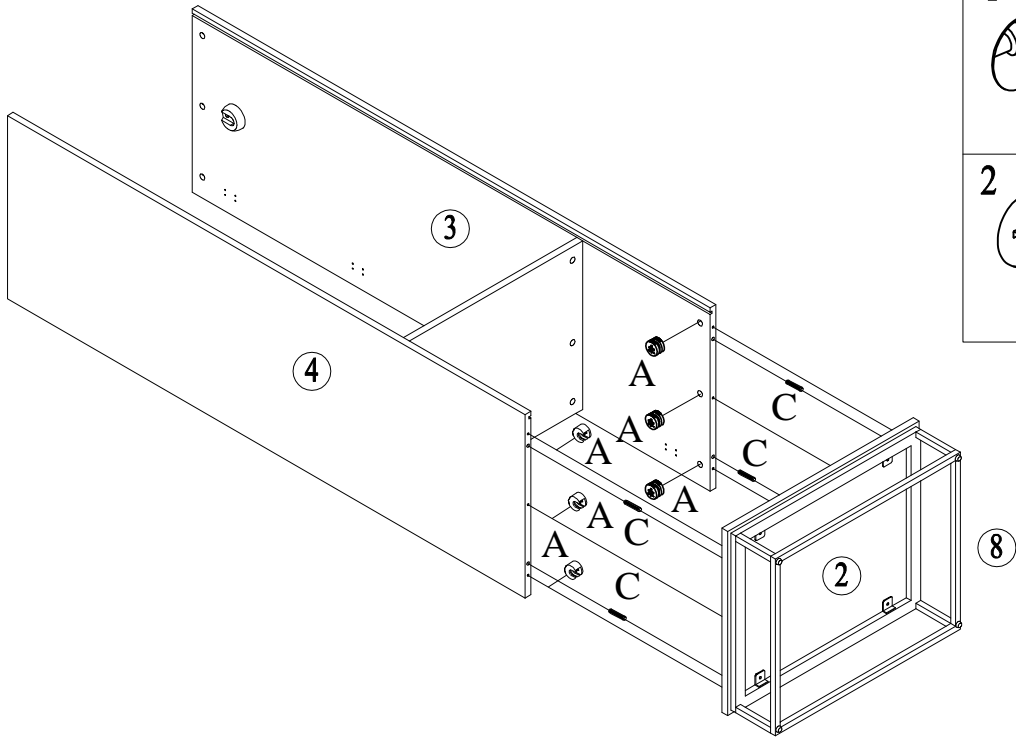

7

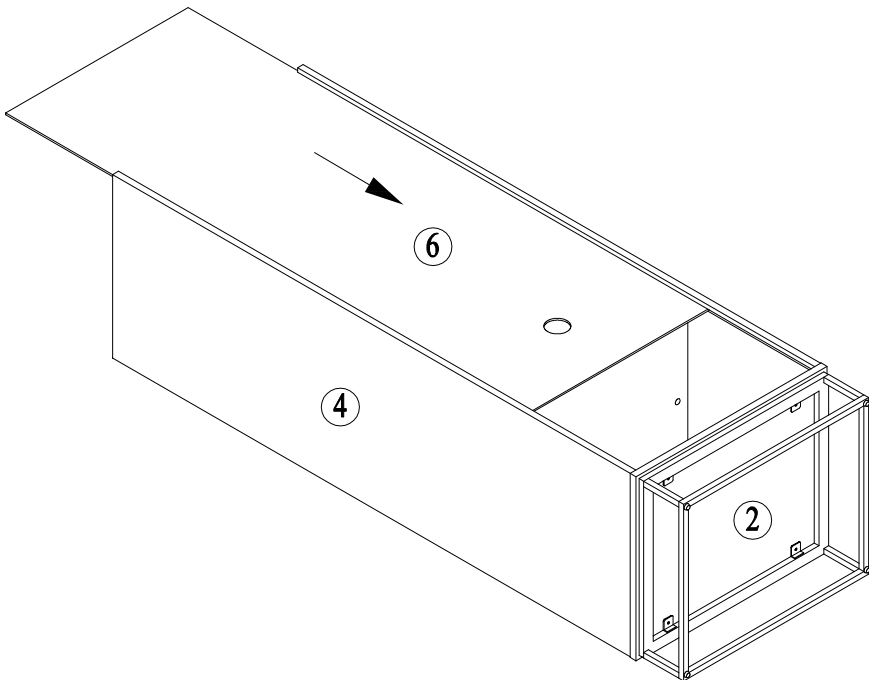

8

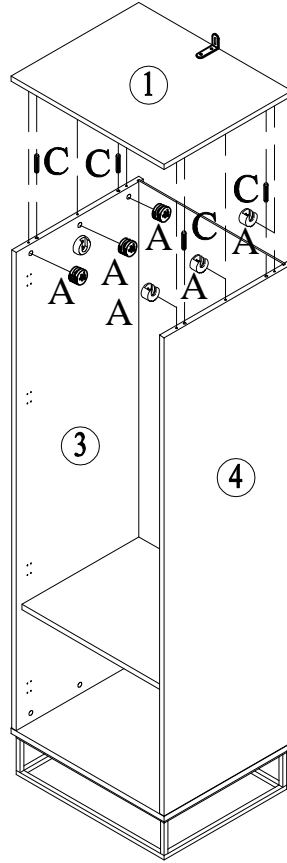
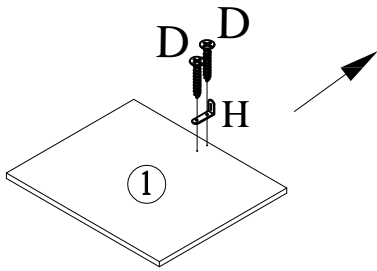
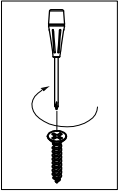

1

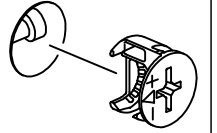

2

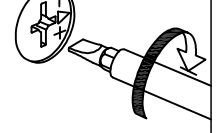

D

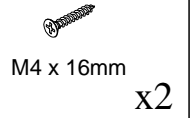

H

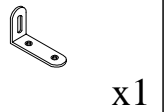

C

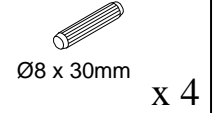

A



9

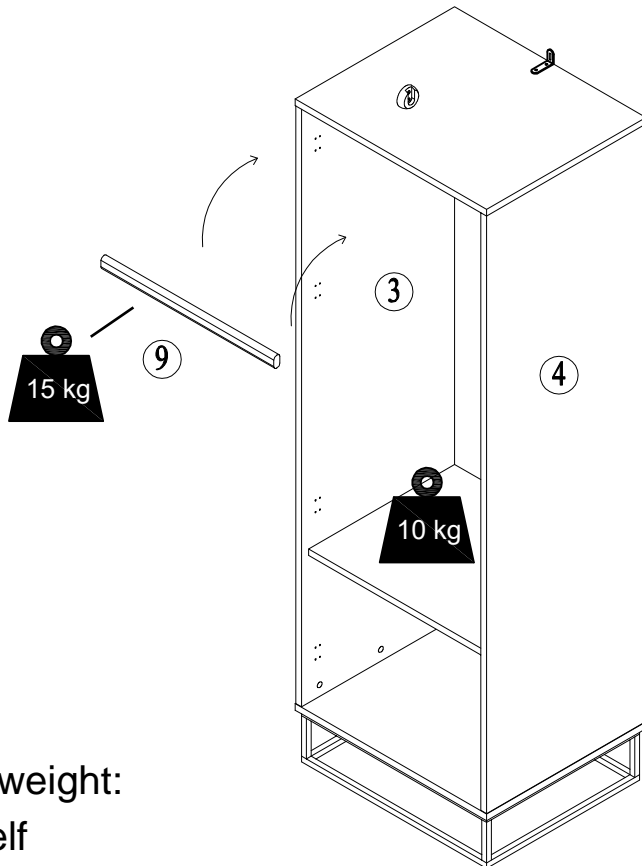

Max loading weight:  
10kgs on shelf  
15kgs for hanger



10

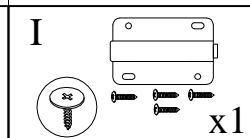
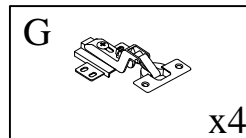
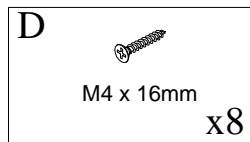
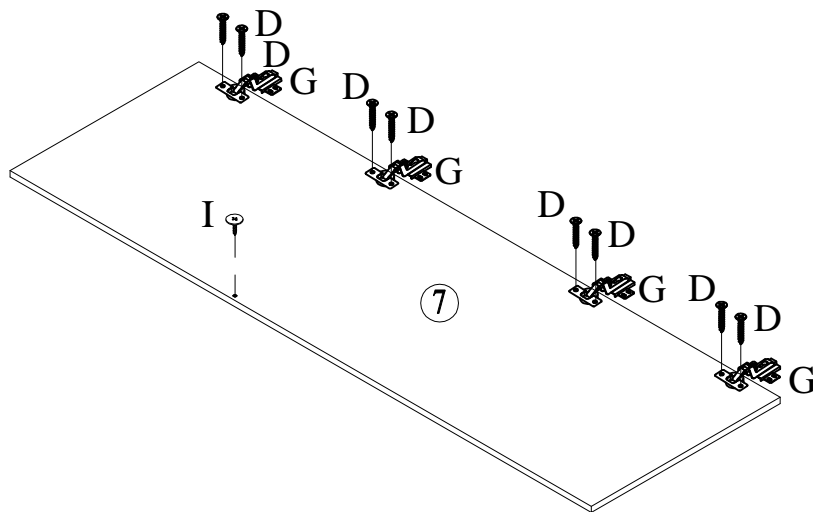

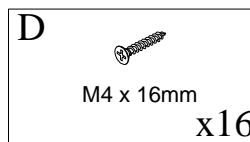
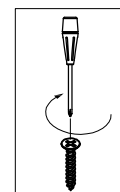
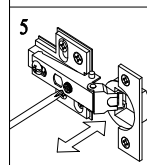
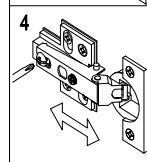
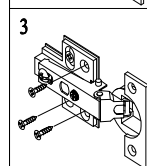
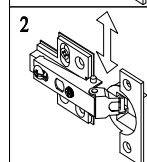
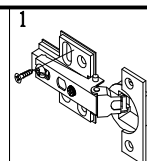
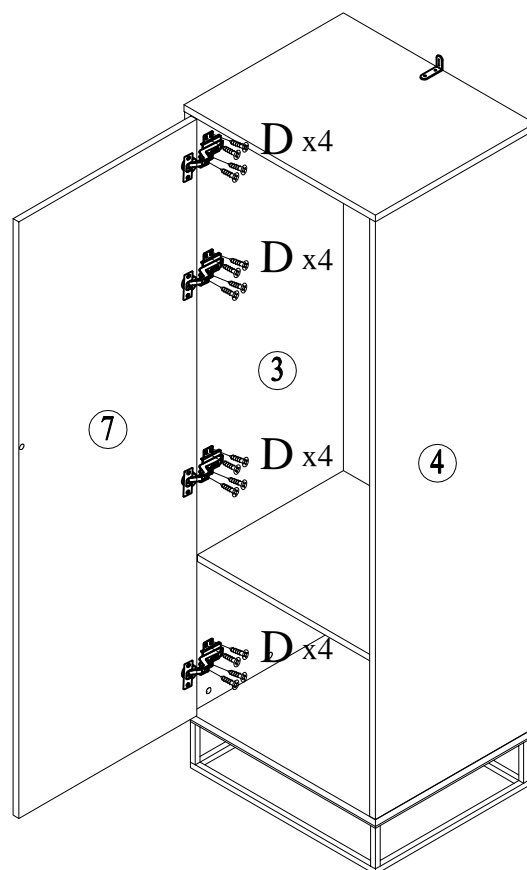

11

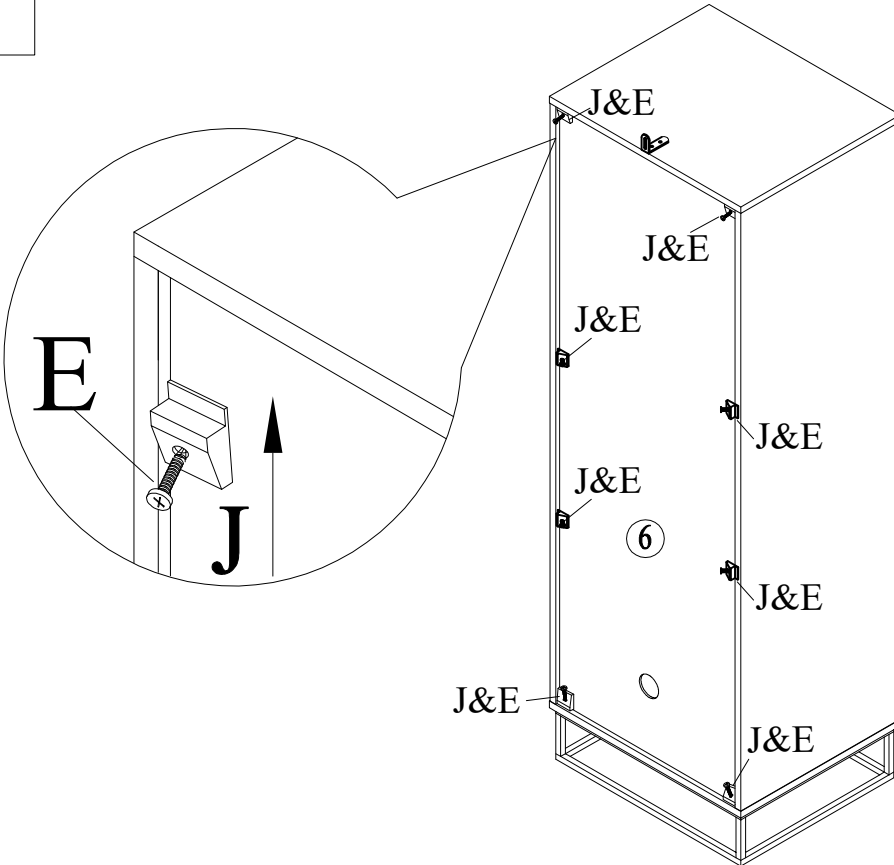

12







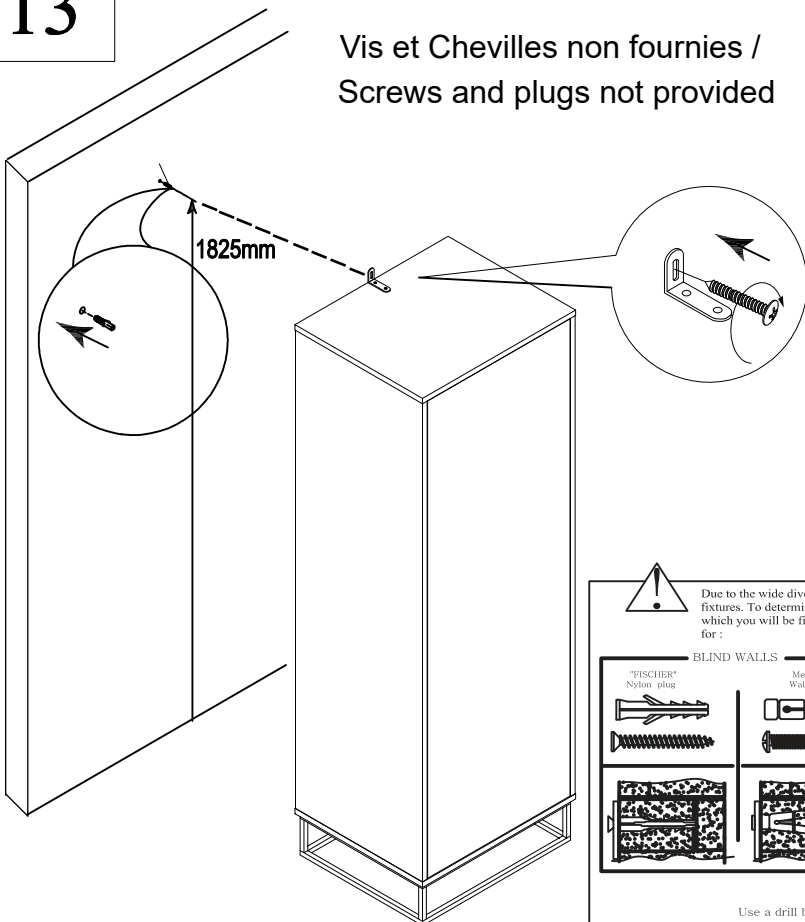

E		M3 x 16mm	x8
J			x8

13

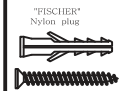
Vis et Chevilles non fournies /  
Screws and plugs not provided

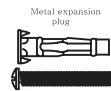
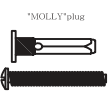

Due to the wide diversity of wall or partition types, we cannot provide you with suitable attachment fixtures. To determine which attachment fixtures to use, you will need to identify the type of wall to which you will be fixing this product. Here are some examples of attachment fixtures recommended for :

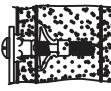
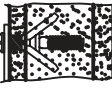
BLIND WALLS		STUDDED WALLS		
"FISCHER" Nylon plug	Metal Wall plug	Nylon winged Wall plug	Metal expansion plug	"MOLLY" plug
				
				

Use a drill bit that is compatible in size with the hardware used and the type of wall

# Jotex information about products with odour.

## ENG - Jotex information about products with odour.

All people are different and have different perceptions about what smells good and what smells bad. If you are sensitive to scents, you may feel that a product smells bad which we at Jotex did not perceive as smelling bad. If this is the case, it is usually enough to air out the product for three to four days. Most undesired scents disappear by then.

**If the scent does not go away after airing, it may be due to several things:**

- Surface treatments like varnish or paint may have a strong scent. This usually disappears with time.
- Glue may also have a strong scent, which also disappears with time.
- Products that have been wrapped in plastic may have a scent when unpacked. Airing usually helps.

- Wood, particle board and plywood always have some degree of scent, which some people may find unpleasant.

### **Other things that affect scent**

Remember that scents are more noticeable in a small room than a big one. Scents may be more noticeable in a room with little ventilation than a well-ventilated room.

### **What should I do with a product with an unpleasant scent?**

If the product still has an unpleasant scent after being aired out for several days, and you feel that it does not meet your expectations for that reason, you are welcome to return it to us. You can read more on our website [jotex.se](http://jotex.se), where you will find information at the bottom of the page under the heading General Rules. But of course, we hope you are satisfied with your product.

## SE - Jotex information om produkter som luktar

Alla vi människor är olika och har olika uppfattning om vad som luktar gott och vad som luktar illa. Är du känslig för dofter kan du uppleva att en produkt luktar illa som vi på Jotex inte uppfattat som illaluktande. Skulle så vara fallet brukar det räcka att du luftar produkten i tre till fyra dagar. De flesta oönskade dofter försvinner då.

**Skulle lukten inte försvinna trots luftning kan det bero på olika saker:**

- Ytbehandling som lack eller färg kan lukta starkt. Det brukar försvinna med tiden.
- Lim kan också lukta starkt och även den doften försvinner med tiden.
- Produkter som varit förpackade i plast kan lukta vid uppackning. Luftning brukar hjälpa.

- Trä, spånskivor och plywood släpper alltid mer eller mindre doft, denna kan av vissa uppfattas som obehaglig.

### **Annat som påverkar doften**

Tänk på att i ett litet rum känns lukt mer än i ett stort rum. I ett rum med låg ventilation känns lukt mer än i ett rum med hög ventilation.

### **Vad ska jag göra med en vara som luktar obehagligt**

Om produkten inte slutat lukta obehagligt efter några dagars luftning och du upplever att den därför inte motsvarar dina förväntningar är du välkommen att returnera den till oss. Du kan läsa mer på vår hemsida [jotex.se](http://jotex.se) och där hittar du informationen längst ner på sidan under rubriken Allmänna föreskrifter. Men vår stora förhoppning är förstås att du är nöjd med din vara.

## NO - Jotex' informasjon om produkter som lukter.

Vi mennesker er forskjellige og har ulike oppfatninger om hva som lukter godt og hva som lukter vondt. Er du duftsensitiv, kan du oppleve at et produkt lukter vondt, selv om vi på Jotex oppfatter noe annet. Er dette tilfellet, pleier det å være nok at du lufter produktet i tre til fire dager. Da forsvinner de fleste uønskede lukter.

**Dersom lukten ikke blir borte til tross for luftning, kan dette skyldes ulike ting:**

- Overflatebehandling som lakk eller farge kan lukte sterkt. Det pleier å forsvinne med tiden.
- Lim kan også lukte sterkt, og selv den lukten forsvinner med tiden.
- Produkter som har vært innpakket i plast, kan lukte når de pakkes opp. Luftning bruker å hjelpe.

- Tre, sponplater og kryssfiner avgir alltid mer eller mindre lukt, og noen synes dette er ubehagelig.

### **Andre ting som påvirker lukten**

Husk at lukt merkes mer i et lite rom enn i et stort rom. I et rom med lav ventilasjon merkes lukt mer enn i et rom med høy ventilasjon.

### **Hva kan jeg gjøre med en vare som lukter ubehagelig?**

Dersom produktet ikke slutter å lukte ubehagelig etter noen dagers luftning, og du opplever at det derfor ikke tilsvarer dine forventninger, kan du returnere det til oss. Du kan lese mer på nettsiden vår, [Jotex.no](http://Jotex.no). Der finner du informasjonen nederst på siden under punktet Generelle vilkår. Vårt store håp er derimot at du er fornøyd med varen din.

## FI - Jotex – tietoa tuotteista, joissa on haju.

Kaikki ihmiset ovat erilaisia ja kaikilla on oma käsityksensä siitä, mikä tuoksuu hyvälle ja mikä pahalle. Jos olet tuoksuherkkä, voit kokea tuotteen pahanhajuiseksi, vaikka Jotex ei pidä sitä pahanhajuisena. Siinä tapauksessa yleensä riittää, että tuuletat tuotetta kolme tai neljä päivää. Useimmat ei-toivotut -hajut häviävät siinä ajassa.

**Mikäli haju ei katoa, voi siihen olla monia eri syitä:**

- Pintakäsittely, kuten lakka tai maali, on voimakkaan hajuihin. Haju häviää yleensä ajan myötä.
- Myös liima voi olla voimakkaan hajuihin, mutta myös sen haju häviää ajan myötä.
- Muoviin pakatut tuotteet voivat haista pakkauksesta poistamisen jälkeen. Tuuletuksesta on yleensä apua.

- Puussa, lastulevyssä ja vanerissa on aina jonkinlainen haju, joka ei tuntua jonkun mielestä epämiellyttävältä.

### **Muuta tuoksuun vaikuttavaa**

Huomioi, että pienessä huoneessa haju tuntuu voimakkaammin kuin isossa huoneessa. Heikosti ilmastoidussa huoneessa haju tuntuu voimakkaammin kuin tehokkaasti ilmastoidussa huoneessa.

### **Mitä teen tuotteelle, jossa on epämiellyttävä haju**

Mikäli tuote haisee epämiellyttävältä vielä muutaman päivän tuuletuksen jälkeen eikä sen vuoksi vastaa odotuksiasi, voit palauttaa sen meille. Lue lisää [jotex.fi](http://jotex.fi)-sivun alareunasta kohdasta Yleiset ehdot. Toivomme tietenkin, että olet tyytyväinen tuotteeseesi.

## DK - Jotex information om produkter som lugter.

Alle mennesker er forskellige og har forskellige opfattelser af, hvad der lugter godt og hvad der lugter dårligt. Hvis du er følsom over for lugte, kan du opleve, at et produkt lugter dårligt, som vi hos Jotex ikke opfatter som ildelugtende. Hvis dette er tilfældet, er det normalt nok, at du lugter produktet i tre til fire dage. Så forsvinder de fleste uønskede lugte.

### Hvis lugten ikke forsvinder trods luftning, kan det skyldes flere ting:

- Overfladebehandling som lak eller maling kan lugte kraftigt. Lugten plejer at forsvinde med tiden.
- Lim kan også lugte kraftigt, og selv den lugt forsvinder med tiden.
- Produkter, der er pakket i plast, kan lugte, når de pakkes ud. Luftning plejer at hjælpe.

## DE - Jotex-Informationen über stark riechende Produkte.

Wir Menschen sind alle sehr unterschiedlich, und wir haben ganz unterschiedliche Vorstellungen davon, was gut und was schlecht riecht. Wenn Sie empfindlich auf Gerüche reagieren, kann es sein, dass Sie ein Produkt als schlecht riechend empfinden, auf das wir bei Jotex nicht negativ reagieren. Sollte das der Fall sein, dann reicht es in der Regel, wenn Sie das Produkt drei bis vier Tage lüften. Die meisten unerwünschten Gerüche sind danach verschwunden.

### Falls sie jedoch trotz ausgiebigen Lüftens nicht verschwinden, kann es hierfür verschiedene Gründe geben:

- Oberflächenbehandlungen wie Lacke und Farben können intensiv riechen. Diese Gerüche verschwinden jedoch mit der Zeit.
- Kleber können ebenfalls stark riechen, aber auch sie verschwinden mit der Zeit.
- In Kunststoff verpackte Produkte können beim Auspacken einen unangenehmen Geruch verbreiten. Hier hilft normalerweise Lüften.

## IT - Informazione sui prodotti con odore forte.

Ogni persona è diversa e ha percezioni diverse su quali odori sono buoni o cattivi. Se sei molto sensibile agli odori, un prodotto che per noi di Jotex è inodore, per te potrebbe avere un odore sgradevole. Se così fosse, di solito basta arieggiare il prodotto per 3-4 giorni per far sparire la maggior parte degli odori.

### Se, dopo aver arieggiato il prodotto, l'odore non è sparito potrebbero esserci diversi motivi:

- Alcuni trattamenti superficiali come lacche e vernici possono emettere odori forti, che di solito scompaiono con il passare del tempo.
- Anche le colle possono emettere odori forti, ma anche questi scompaiono con il tempo.
- I prodotti che sono stati imballati in plastica possono avere un odore sgradevole quando vengono estratti dall'imballaggio, normalmente l'odore scompare arieggiando il prodotto.

## FR - Informations Jotex au sujet de l'odeur des produits

Nous avons tous une sensibilité différente en matière d'odeurs lorsqu'il s'agit de définir ce qui sent bon ou non. Si vous êtes sensible aux odeurs, il est possible que vous trouviez qu'un produit dégage une odeur désagréable sans que nous, chez Jotex, ne l'ayons remarqué. Dans ce cas, il suffit généralement d'aérer le produit pendant trois ou quatre jours. La plupart des odeurs désagréables auront alors disparu.

### Si l'odeur était toujours présente, cela peut provenir de différents facteurs :

- Les traitements de surface tels que les vernis ou les peintures peuvent dégager une odeur forte. En règle générale, celle-ci s'estompe avec le temps.
- La colle peut aussi sentir fort, mais cette odeur se dissipe également avec le temps.
- Les produits enfermés dans un emballage plastique peuvent dégager une odeur à l'ouverture. Le fait d'aérer le produit se révèle souvent suffisant.

## PL - Informacje marki Jotex na temat zapachu produktów

Każdy człowiek jest inny i inaczej postrzega to, co pachnie ładnie i to, co pachnie brzydko. Jeśli masz wrażliwy nos, może Ci się wydawać, że produkt, który naszym zdaniem ma neutralny zapach, pachnie brzydko. W takim przypadku zwykle wystarczy poczekać kilka dni, aż zapach wywietrzeje. Wówczas większość nieprzyjemnych w Twoim odczuciu zapachów zniknie.

### Może się zdarzyć, że zapach nie zniknie pomimo wietrzenia – zależy to od kilku czynników:

- Produkt ma warstwę zewnętrzną z lakieru lub farby, które mogą mieć intensywny zapach. Zwykle słabnie i ostatecznie znika z czasem.
- Również klej może mieć intensywny zapach, jednak ten także wywietrzeje z czasem.
- Produkty, które były zapakowane w tworzywa sztuczne, mogą wydzielać zapach po rozpakowaniu. Zwykle wystarczy przewietrzyć pomieszczenie, aby się go pozbyć.

- Træ, spånplader og krydsfiner afgiver altid mere eller mindre lugt, som nogle måske opfatter som ubehagelige.

### Andet som påvirker lugten

Husk at i et lille rum virker lugten kraftigere end i et stort rum. I et rum med lav ventilation er lugten mere fremtrædende end i et rum med høj ventilation.

### Hvad skal jeg gøre med et produkt, der lugter ubehageligt

Hvis produktet ikke er holdt op med at lugte ubehageligt efter et par dages luftning, og du føler, at produktet derfor ikke lever op til dine forventninger, er du velkommen til at returnere det til os. Du kan læse mere på vores hjemmeside [jotex.dk](http://jotex.dk), hvor du også finder informationen nederst på siden under overskriften Generelle vilkår. Men det er naturligvis vores håb, at du er tilfreds med dit produkt.

- Holz, Span- und Sperrholzplatten riechen immer mehr oder weniger stark, was von empfindlichen Personen als unangenehm empfunden werden kann.

### Sonstige geruchsverstärkende Parameter

Bedenken Sie stets, dass Gerüche in kleinen Räumen intensiver wirken als in großen Räumen. In einem Raum mit geringer Lüftung empfindet man Gerüche stärker als in gut gelüfteten Räumen.

### Was mache ich mit einem unangenehm riechenden Produkt?

Falls das Produkt selbst nach einigen Tagen ausgiebigen Lüftens immer noch unangenehm riecht und Sie der Ansicht sind, dass es daher nicht Ihren Erwartungen entspricht, bitten wir Sie, es an uns zurückzuschicken. Weitere Einzelheiten hierzu finden Sie auf unserer Website [jotex.se](http://jotex.se), und zwar am Ende der Website unter „Allgemeine Vorschriften“. Grundsätzlich hoffen wir jedoch, dass Sie mit unseren Produkten zufrieden sind.

- Legno, truciolato e compensato hanno un loro odore, che per alcune persone potrebbe risultare sgradevole.

### Altri parametri che influenzano l'odore

In una stanza piccola l'odore sembra più forte che in una stanza grande. In una stanza con poca ventilazione l'odore sembra più forte che in una stanza con molta ventilazione.

### Cosa posso fare con un prodotto che ha un odore sgradevole?

Se il prodotto continua ad emettere un odore sgradevole dopo averlo arieggiato per un paio di giorni e ritieni che non corrisponda alle tue aspettative, puoi restituirlo. Sul nostro sito [jotex.it](http://jotex.it), sul fondo della pagina, sotto il titolo "regole generali", troverai ulteriori informazioni. Naturalmente, ci auguriamo che tu sia soddisfatto dei prodotti acquistati.

- Le bois, les panneaux de particules et le contreplaqué sont toujours plus ou moins odorants, ce qui peut être ressenti comme une gêne par certains.

### Autres facteurs ayant un impact sur les odeurs

Tenez compte du fait que les odeurs sont plus concentrées dans une petite pièce que dans une grande. De même, dans une pièce peu ventilée, l'odeur sera plus présente que dans une pièce bien aérée.

### Que faire si je trouve que mon produit dégage une odeur désagréable

Si après avoir aéré le produit pendant plusieurs jours, vous constatez qu'il dégage toujours une odeur désagréable et qu'il ne correspond donc pas à vos attentes, vous pouvez bien sûr nous le retourner. Pour plus d'informations à ce sujet, consultez la rubrique Conditions générales que vous trouverez en bas de la page d'accueil de notre site [jotex.se](http://jotex.se). Mais bien entendu, nous espérons avant tout que nos produits vous donneront pleine satisfaction.

- Drewno, wióry i sklejka zawsze wydzielają jakiś zapach, który niektóre osoby mogą postrzegać jako nieprzyjemny.

### Inne czynniki wpływające na odczucia zapachu

Pamiętaj, że w małym pomieszczeniu zapach będzie zawsze mocniej odczuwalny niż w dużym. W pomieszczeniu o słabej wentylacji wszystkie zapachy czuć intensywniej niż w pomieszczeniu o dobrej wentylacji.

### Co zrobić z produktem, który pachnie nieprzyjemnie

Jeśli produkt nie przestał pachnieć nieprzyjemnie po kilku dniach wietrzenia i w związku z tym uważasz, że nie spełnia on Twoich oczekiwań, możesz go zwrócić. Więcej informacji na ten temat znajduje się w naszej witrynie ([jotex.se](http://jotex.se)) w sekcji Zasady ogólne. Jednak oczywiście mamy nadzieję, że nasz produkt Cię nie rozczaruje.