

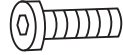



ASSEMBLY INSTRUCTION

A		x4
B		x5
C		x1
D		x1

